

ENFORCING CAREFLOWS AND TREATMENT CONSENTS IN ELECTRONIC
MEDICAL RECORD SYSTEMS

by

Bo Yu
A Dissertation
Submitted to the
Graduate Faculty
of
George Mason University
in Partial Fulfillment of
The Requirements for the Degree
of
Doctor of Philosophy
Information Technology

Committee:

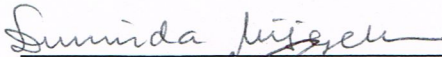

Dr. Duminda Wijesekera, Dissertation Chair

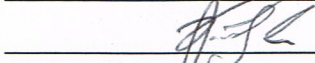

Dr. Paulo Costa, Dissertation Co-Chair



Dr. Angelos Stavrou, Committee Member

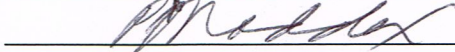

Dr. Peggy J Maddox, Committee Member

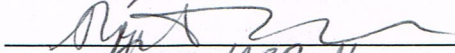

Dr. Stephen Nash, Senior Associate Dean

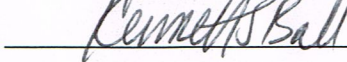

Dr. Kenneth S. Ball, Dean, Volgenau School
of Engineering

Date: _____

Fall Semester 2014
George Mason University
Fairfax, VA

Enforcing Careflows and Treatment Consents in Electronic Medical Record Systems

A Dissertation submitted in partial fulfillment of the requirements for the degree of
Doctor of Philosophy at George Mason University

by

Bo Yu
Master of Science
George Mason University, 2007
Bachelor of Computer Science
Beijing University of Aeronautics and Astronautics, 1999

Director: Duminda Wijesekera, Professor
Department of Information Technology

Fall Semester 2014
George Mason University
Fairfax, VA



This work is licensed under a [creative commons attribution-noncommercial 3.0 unported license](https://creativecommons.org/licenses/by-nc/3.0/).

DEDICATION

This is dedicated to my parents Shounan Yu & Zhihua Qiu; my sister's family Renee, Roger, Michelle and Conrad Cliff; and to my loving son David Ni and god-son BoMi. I am grateful for your love and support.

ACKNOWLEDGEMENTS

I am fortunate to have Professors Duminda Wijesekera and Paulo Costa as my advisors. This thesis was made possible due to their masterly guidance. They steadfastly supported me from start to finish over all these years. I remember occasions when feeling discouraged about the direction of my research but inevitably a meeting with my advisors provided clarity and reinvigorated my enthusiasm. I feel privileged to have them as my supervisors. I also thank other members of my PhD committee, Professors Angelos Stavrou and Peggy J Maddox, for their advice and suggestions.

I also appreciate help from Xiaodong Zhong, who was always ready to lend a helping hand; and from Devika Wijesekera, who consistently provided valuable information and opinion.

I owe a lot to my colleagues at Center for Assurance Research & Engineering who supported me, attended my practice presentation and provided invaluable suggestions.

I owe my deepest gratitude to my family to whom this is dedicated. I know I can always count on my family.

Lastly, and most importantly, I wish to thank my son David, who endured many lonely evenings while I worked late in the lab. His unconditional love, understanding, and support helped immeasurably to sustain me.

TABLE OF CONTENTS

	Page
List of Tables	vii
List of Figures	viii
List of Abbreviations and Symbols.....	x
Abstract.....	xi
CHAPTER ONE INTRODUCTION.....	1
1.1 Introduction.....	1
1.2 Motivation and Problem Definition	4
1.3 Dissertation Statement	7
1.4 Scope of Research.....	9
1.5 Significance of My Contribution	9
CHAPTER TWO THE ARCHITECTURE	12
2.1 Slow Evolution to EMR Systems	12
2.2 Architecture of the Workflow-base EMR System	15
CHAPTER THREE WORKFLOW-BASED EMR SYSTEM.....	25
3.1 Introduction and Background	25
3.2 Medical Workflow	27
3.2.1 Medical Treatment Workflow.....	28
3.2.2 Embedded Checks in Medical Treatment Process.....	30
3.2.3 Placing Detrimental Time-out as Early as Possible	34
3.3 Modeling Complex Treatment Workflows.....	36
3.3.1 Generate a HD Workflow	37
3.3.2 High-Level HD Workflow	38
3.3.2.1 The YAWL Notation in Brief.....	38
3.3.2.2 The high-level HD workflow	39
3.3.2.3 “Do Hemodialysis” Sub-workflow.....	42

3.3.3	Create Workflow Enforced HD EMR.....	46
3.3.4	Evaluation and Conclusion	53
CHAPTER FOUR	CONSENT-BASED WORKFLOW CONTROL	56
4.1	Background and Related Works	56
4.2	Consent Enforcement in Workflow-based EMR System	58
4.3	Creating Consent Enforcement Mechanisms in Workflow-based EMRs.....	59
4.3.1	Main Issues Involving Treatment Consent	62
4.3.2	Consent Management System.....	63
4.3.3	Implementation	69
4.3.4	Evaluation and Conclusion	74
CHAPTER FIVE	ONTOLOGY FOR MEDICAL TREATMENT CONSENT.....	75
5.1	Introduction.....	75
5.2	Ontologies	76
5.3	Ontologies in the Healthcare Domain.....	77
5.4	Related Work	78
5.5	Ontology-based Reasoning to Derive Informed Treatment Consents	79
5.5.1	Entities of Medical Treatment Consent Ontology	80
5.5.2	Classes, Properties of the Treatment Consent Ontology	81
5.5.3	Properties (express the relationship of two classes) in Ontology	82
CHAPTER SIX	RULE-BASED IMPLEMENTATION IN WORKFLOW-BASED EMR SYSTEM.....	84
6.1	Introduction.....	84
6.2	Informed Treatment Consent Rules	84
6.3	Deriving Informed Treatment Consents	88
6.4	Evaluation	91
CHAPTER SEVEN	CONCLUSIONS AND FUTURE WORK.....	98
7.1	Conclusions.....	98
7.2	Future Work	99
REFERENCES	100

LIST OF TABLES

	Page
Table 1	38
Table 2	61
Table 3	60
Table 4	62
Table 5	82
Table 6	87
Table 7	91
Table 8	95

LIST OF FIGURES

Figure	Page
Figure 1 Medical Information System in 1960s~1970s	13
Figure 2 Medical Information System in 1980s.....	13
Figure 3 Medical Information System in 1990s.....	14
Figure 4 High Level View of Extending EMR System.....	15
Figure 5 Workflow-based EMR System Architecture	17
Figure 6 Interactions between the WfMS and EMR System per session.....	17
Figure 7 Workflow-based EMR System with Consent Management Architecture	19
Figure 8 Interactions between the WfMS and EMR System per Session	20
Figure 9 Enhanced Workflow-based EMR System Architecture	22
Figure 10 Interactions between the WfMS, the EMR System and CMS per Session.....	23
Figure 11 an Example of Medical Treatment Workflow	29
Figure 12 Sample Procedure Timeline (original).....	30
Figure 13 the YAWL Notation.....	38
Figure 14 the High-Level HD Workflow	40
Figure 15 the HD Process.....	43
Figure 16 the Architecture of Workflow Enforced HD EMR System	47
Figure 17 Dialysis Integration in the OpenMRS.....	48
Figure 18 WfMS – EMR system Interaction (per session, implemented using YAWL engine)	49
Figure 19 Find a Patient from OpenMRS System.....	51
Figure 20 Care Provider Starts a “Do Dialysis” Workflow	51
Figure 21 Workflow Inquire Data Form	52
Figure 22 Patient Pre-Assessment Abnormal.....	52
Figure 23 Trigger Charge Nurse “Do Pre-Assessment” Task.....	53
Figure 24 Finished a “do dialysis” Workflow.....	53
Figure 25 Consent Management System.....	64

Figure 26	Workflow Engine – EMR Interaction (per session, implement by using YAWL engine [6]).....	65
Figure 27	Example of a Treatment Specification.....	66
Figure 28	Adding Consent Management System as Custom Service into YAWL.....	67
Figure 29	Consent Management Workflow	68
Figure 30	Find a Patient from OpenMRS System.....	70
Figure 31	Check Treatment Consent Requirements.....	70
Figure 32	Consent has been Given by the Patient.....	71
Figure 33	Patient Submits an “ <i>Accept Treatment</i> ” Consent.....	73
Figure 34	Patient Submit a “ <i>Reject Treatment</i> ” Consent.....	74
Figure 35	High-level view of ontology-based knowledge reason.....	79
Figure 36	Entities of treatment consent ontology	83
Figure 37	Outcome of the proof of patient maturity using Pellet reasoner.....	96

LIST OF ABBREVIATIONS AND SYMBOLS

Electronic Medical Records.....	EMR
hemodialysis.....	HD
Information Technology	IT
Electronic Checklist	ECL
Operating Room	OR
Workflow Management System	WfMS
Consent Management System.	CMS
Health Level 7.....	HL7
Local Area Network	LAN
User Interface	UI
identification.....	I.D.
Ontology Service	OS
Consent Service	CS
Ontology Web Language	OWL
pre-operative	Pre-Op
Post-Anesthesia Care Unit	PACU
Time-out Point	TP
Clinical EMR	C-EMR
Surgical EMR	S-EMR
Peritoneal Dialysis	PD
Graphic User Interface	GUI
Unified Modeling Language	UML
Do Not Resuscitate	DNR
Do Not Intubate	DNI
Semantic Web Rule Language	SWRL
Systematized Nomenclature of Medicine	SNOMED

ABSTRACT

ENFORCING CAREFLOWS AND TREATMENT CONSENTS IN ELECTRONIC MEDICAL RECORD SYSTEMS

Bo Yu, Ph.D.

George Mason University, 2014

Dissertation Director: Dr. Duminda Wijesekera

Procedure-oriented medical treatments specify processes that embody years of experience, must be followed by care team members and have become standards of care that avoid known care procedure pitfalls. Referred to as “medical treatment workflow,” these workflows are not embedded in, nor enforced by, existing Electronic Medical Record (EMR) systems. This dissertation shows a method to incorporate medical workflows into existing EMR systems with flexibility to handle unanticipated exceptions. Developing prototypes for surgical and hemodialysis (HD) procedures shows the utility and flexibility of the proposed method.

Second, receiving medical treatment, choosing an alternative treatment or terminating treatment requires the patient’s explicit or derived informed consent whether or not electronic systems are used. Failure to obtain informed consent is a top-ten reason for medical malpractice claims in the United States. Consequently, e-healthcare systems

need effective, indeed flawless, consent management. This dissertation provides a method to incorporate medical treatment consent into existing EMR systems.

The responsibility of obtaining consent in EMR systems is complex in and of itself, but much more so for obtaining appropriate consent from minors. I establish the utility and flexibility of this method by prototyping a system that enforces treatment consent for adolescent and adult treatments across all 50 states that have state-specified regulations that vary widely. I further establish that these varying and changing regulations can be enforced by a single system.

CHAPTER ONE INTRODUCTION

1.1 Introduction

Today's healthcare industry increasingly pays attention to patient safety, quality of care, risk management and medical data security and privacy. Computer-based Information Technology (IT) in healthcare has evolved and changed the way computing systems support healthcare service delivery, with examples including EMR systems and personal health record systems.

Quite unrelated, medical care delivery has continued to address minimizing medical errors in the desire to provide higher quality medical care. Multiple reasons underlie medical errors. One is failure follow treatment processes, causing errors in administering treatments, in performing procedures, or tests. A report sponsored by the Pennsylvania Patient Safety Authority found that between November 1, 2008 and October 31, 2009, Pennsylvania HD facilities reported having 12.9% incidents caused by failure to follow policies or protocols designed for HD [1]. In medicine, most medical processes, especially those designed to deliver standardized treatment processes, are procedure-oriented-- namely, collecting sequences of actions that are required to provide a particular standard of care by taking the healthcare team from first consult through continuous treatment regimens. Specialty boards establish treatment procedures as practice standards. Medical process effectuates those standards, and consists of activities

to be completed by the care team. Using engineering parlance, these are commonly referred to as workflows. In this dissertation, following some usage [2 - 3] I call medical treatment process “careflow.”

Standardized treatment procedures mostly require performing multiple checks that are documented in guidelines, standards, policies, etc. Many healthcare providers, medical practitioners, and researchers have attempted to reduce medical errors by designing and enforcing safety checklists [4 - 6], new policies, guidelines, and standards [7 - 8] to govern medical procedures. For example, the World Health Organization developed a checklist to improve the safety of surgical patients worldwide [9]. The Joint Commission approved the Universal Protocol for Preventing Wrong Site, Wrong Procedure and Wrong Person Surgery, which became effective July 1, 2004 for all accredited hospitals, ambulatory care and office-based surgical facilities [10]. Mandating that during a surgery, multiple nurses count swabs, used equipment, and threads before closing a wound is an example of a recommendation that satisfies both these mandates [11].

In past decades, many authors and case studies focused on integrating standard medical processes with EMR systems for improving patient safety, monitoring compliance of process and measuring outcomes [12]. Early on, some researchers proposed a range of methodologies, such as using a guideline execution engine [13], E-Guideline [14], or an implementing checklist as a component of EMR functionality and generating an Electronic Checklist (ECL) [15-17] in EMR system to deliver recommendations and/or alerts within a clinician’s workflow.

Later, many healthcare organizations employed computer systems for improving patient safety. These medical systems include Context-aware systems for the Operating Room (OR) [18 -19], “Guideline-base Careflow System [20]” that help healthcare providers in reducing communication misunderstandings and coordinating work and the like.

In recent years, some researchers began using workflow management techniques to help diagnose disease, assist in medical decision-making, optimize scheduling medical events and aid in therapy [21 - 23]. My dissertation differs because I do not address diagnosis or medical decision-making.

Also addressed herein is treatment consent. Every provider must obtain consent from a patient or guardian before treatment; that has become a mandatory component of medical practice. The American Medical Association states that “obtaining informed consent is an ethical obligation of the practice of medicine and a legal requirement per statute and case law in all 50 States.” [24] Currently, the most common approach for managing informed consent forms in EMR systems is by storing them as an electronic format, restricting them to basic record keeping. Consequently, although the consent exists as a scanned document, it is not used by electronic means during the treatment process, and relies on caregivers to enforce them. Therefore, providing advanced features such as consistent enforcement of informed consent laws, regulations, and guidelines in using electronic monitoring capabilities of the EMR is missing in practice. In addition, scanning consent forms is estimated to cost hospitals on average \$80,000 per year [25], while medical providers may have poor enforcement that results in obtaining wrong or

inapplicable consents. Failure to obtain informed consent is a top-ten reason for generating medical malpractice claims; “a properly completed consent form would have prevented 45% of errors on surgery wrong sites.” [26]

The third issue addressed herein is the role played by “Informed Consent” in careflows. Consent can affect the next procedure scheduled in the treatment workflow. Absence of informed consents in a treatment workflow may cause malpractice.

1.2 Motivation and Problem Definition

Many publications have advocated checklists to ensure patient safety. Several physician studies have shown that checklists reduce morbidity and mortality [27-32] as well. Dr. Atul Gawande’s much publicized TED presentation made this point [33]. Furthermore, many researches demonstrated that using an EMR system to improve treatment efficacy also could reduce treatment errors [34-35]. However, the methods used with EMR systems, such as E-Guideline and ECL to help enforce the checks and guideline-based careflow system, are not combined with treatment workflow, nor are those required checks enforced by the systems. As well, proposed methodologies are not embedded in existing EMR systems. Therefore, the current methodologies are unable to ensure checks have been done at pre-defined points of the treatment workflow.

Despite the importance of “informed consent” as a medical workflow factor, literature studies concerning enforcement of medical informed treatment consents in existing EMR systems reveal that none can dynamically gain and automatically enforce informed treatment consents. Rather, informed consents remain primarily in the form of paper or scanned electronic documents stored in EMR systems.

The problems:

Attitudes: Using workflow in a medical treatment management system can deliver the significant benefit of systematic management among treatment processes. They can also be used for qualitative reviews of the procedures and outcomes. Healthcare providers have long followed standardized treatment procedures and guidelines.

Nonetheless, a survey produced by J. Kochevar, et al. [36] reported only 5.3% respondents consider “better quality care” should result from using an EMR system for dialysis. However, 23.7% of the respondents were more concerned about “save time”, or “improves record keeping,” factors not directly related to patient safety. Those attitudes, common in other medical sub-disciplines, have inhibited development of EMR systems for healthcare and conducting research on including medical workflow into an EMR system.

Emphasis on EMR systems’ economic benefits and data capabilities:

Consequently, many early EMR systems focused more on economic benefits [37-38], such as efficient billing software for medical organizations. Subsequently, due to advances in new technologies and treatment regimes, medical treatment processes became more complex, generating more medical data. Most medical facilities spent effort maintaining and manipulating data related to treatments to reduce data input errors, maintenance, processing and reporting. Therefore, much effort spent on EMR systems focused on integrating existing EMR systems with other EMR software, report generating support, decision support at various levels and regulatory compliance. These efforts greatly facilitate the medical industry with better care quality, but this has not fully

improved patients' care due to the lack of integrating clinic workflows into EMR systems, which facilitates conformance to guidelines.

Continued use of paper consents: To treat, to terminate treatment, and to choose among alternative treatments requires the patient or guardian's informed consent. Yet most medical facilities still use paper-based consent forms, even those operating EMR systems.

In summary, when developing and adopting EMR systems, due to limited focus on both support of core care processes and enforcement of standard practices [39-41], EMR systems were *not developed* for:

- 1) Ensuring that care providers follow those medical treatment workflows or improve them to achieve higher quality care;
- 2) Enforcing checks required by procedures/steps; or
- 3) Obtaining and enforcing medical informed consents as required at the points of treatments at the runtime;

Despite existing EMR systems' ability to provide limited assistance to help care teams follow treatment workflows and implement checks, such as alerts and recommendations to care providers at the points of checking, existing EMR systems neither enforce treatment workflow and checks, nor provide runtime supports to obtain informed consents required by treatment procedure.

Integrating Workflow-driven Information Management Systems with any existing EMR system to flexibly support treatment workflow to ensure required checks is challenging. Furthermore, applying a mechanism to implement informed consent

management in existing EMR systems is another challenge. These challenges to tackle the problems identified in Section 1.1 above motivated my research.

1.3 Dissertation Statement

It is possible to:

- (i) Orchestrate mandated workflow requirements expressed in natural language as clinical best practices and operating manuals using generic workflow control methods in existing electronic medical records.
- (ii) Create a generic framework that can flexibly enforce many state laws that govern medical treatment consent for use in an independently developed EMR system.
- (iii) Dynamically alter a workflow-based EMR orchestration based on patients' medical treatment consent.

Regarding Claim (i), my framework specifies treatment workflows using a Workflow Management System (WfMS) that imposes workflow-based orchestration of the treatment process. I implemented this using an open source EMR system openMRS [42] and an open source workflow engine YAWL [43]. I have done two case studies to validate my claim by working with an eye surgeon in creating an EMR system to enforce surgical checkpoint requirements for the entire surgical team.

For a much enlarged case study, I worked with a dialysis center to obtain its workflows and sub-workflows by interviewing the entire staff (approximately 20 people), looking at work descriptions and clinical recommendations, specifying workflows, implementing them using my prototype system and validating their viability. The staff

opined that my system, if enforced on the Dialysis EMR system, would facilitate their work and reduce mistakes. See, Chapter 3.

For Claim (ii), I created a system that consists of an ontology for patient consent and a rule-based system to enforce treatment consents using rules with terms drawn from my treatment consent ontology. To show my framework's viability, I implemented a consent service that auto-generates consent forms from rules specified in my system and applicable to the patient, state law and treatment. If the consent is already available or derivable from existing consents, my system will not request the consent again. If, however, consent has not been given, WfMS will prevent continuation of procedures. My system can encode rules that govern emergency processes where caregivers can provide emergency consents under existing state laws. I demonstrate the system's utility by controlling the openMRS system using the e-consent system that I developed. See, Chapters 4, 5 and 6, where Chapter 4 describes a Consent Management System (CMS) integrating with Workflow-based EMR systems. Chapter 5 describes consent ontology and Chapter 6 describes the rule management system used by CMS.

Regarding Claim (iii), I developed a framework that incorporates my consent service that works as a service to the EMR system's workflow engine. In my framework, the workflow engine takes the careflow specification of the treatment at runtime and the patient's demographic information from the EMR system to generate the consent for each step of the workflow. If treatment consent requirements cannot be derived from existing consents, my system will dynamically generate the consent forms required to be signed by the patient or legal guardian (as determined by state laws). If consents are

unobtainable (including those required for emergency procedures), careflow will be dynamically altered to fit existing alternative procedures.

1.4 Scope of Research

My research has two main systems: Workflow-based EMR; and consent management. Complexity precludes modeling all medical processes to apply and enforce. Fortunately, for providing high quality medical treatments to patients, today's medicine has "many efforts to narrow the complexity of care provision variability ... for procedures." [44] My research focuses on enforcing more stringent procedure-oriented treatment processes and the checks embedded in them, using eye implant surgery and HD as examples. Moreover, in my dissertation I focus on obtaining and evaluating informed consents at the points of starting a treatment step within a well-designed treatment process.

1.5 Significance of My Contribution

First, current EMR systems do not support and enforce pre-defined treatment workflows because they lack a workflow engine within them. In addition, other research does not focus on integrating EMR systems with a treatment workflow management system. I designed a Workflow-based EMR system that extends the functions of existing EMR systems. My system directly controls the progression of predefined and prebuilt care procedures that comply with local or nation standards and policies. Moreover, my Workflow-based EMR system also provides flexibility that caregivers need to continue treatment when, in their judgment, superior care compels moving to the next task despite prerequisite tasks not completed as specified in the workflow. In summary, my system

not only provides medical workflow enforcement, but also provides flexibility. It is also best suited to study healthcare delivery safety and quality care issues. Workflow logs perform an ongoing audit trail to satisfy accountability requirements and can also be used to improve workflow.

First contribution of my research: Workflow-based EMR systems enforcing well-defined treatment workflow to ensure care team following treatment plan from one step to another, thereby avoiding the disadvantages and harm from deviation from procedures and policies. It conforms to healthcare industry development trends by improving patient safety and healthcare treatment outcomes, and by tracking safety and its relationship to the utilized workflows.

In addition, existing EMR systems do not obtain medical treatment consents or enforce them. In another words, they do not effectively manage informed consents, despite treatment consent constituting an important factor that affects steps in the medical treatment workflow. I further extend developed Workflow-based EMR systems by adding consent-based workflow control. Such refined Workflow-based EMR permits consents to be acquired dynamically when required by a procedure in a treatment workflow and automatically evaluated as a care team proceeds from one step to another in the treatment workflow, as well as ensure that a treatment workflow is allowed to move forward only if granted consents.

Second contribution of my research: Managing informed consent in existing EMR systems at runtime significantly benefits medical practitioners. Reasons include, but are not limited to, reducing medical malpractice and potential medical treatment

errors caused by missing informed consents, improving the patient-caregiver relationship, risk management and decreased costs associated with malpractice.

To be valid, informed consent must comply with state and federal laws and regulations applicable to medical sub-disciplines, as well as depend on the type of treatments and location of facilities. Consequently, medical treatment consent is subject to various rules. Some rules are retrieved from combining laws. For instance, in some states, one law may indicate that “*a minor who has married is emancipated*”; whereas another law indicates “*an emancipated minor may consent for medical, dental, or psychiatric care, without parental consent, knowledge, or liability*”; so from two laws it can be inferred that “*married minors are treated as adults allowed to provide medical consents by themselves.*” However, literature studies of consent laws are scarce. In addition, consent rules are dynamic: State and federal consent laws and regulations governing medical sub-disciplines constantly evolve and change. For example, a medical lawsuit of first impression that establishes precedent may trigger a new law or regulation. However, there is no implementation of model health law changes related to treatment consent to obtain appropriate informed consents (gap 1). In this dissertation, I provide a methodology to develop the evaluation rule repository by adopting ontology techniques. I create a medical consent ontology because one did not exist (gap 2).

Third contribution of my research: Developing an ontology for medical treatment consents.

In summary, this enhancement of existing EMR systems improves medical treatment processes and patient informed consent management.

CHAPTER TWO THE ARCHITECTURE

2.1 Slow Evolution to EMR Systems

EMR systems evolved with differing architectures to satisfy different requirements at different stages of technology development. Many treatises [45-47] have detailed EMR system evolution. Today, EMR systems are deemed indispensable.

In the 1960s, a few large medical facilities developed and adopted computerized systems that focused on supporting health care billing processes and management. Large mainframe computers centrally processed these needs.

During the 1970s, in addition to large mainframe-computers, smaller, less expensive computers were installed for health-related information systems in some clinical units that applied standardized treatment and monitoring procedures, such as laboratory and pharmacy [45], where architectural changes were minimal from the 1960s. (See, Figure 1)

In the early 1980s, increasing microprocessor power and affordable personal computers served as catalysts for clinical system development. Many different departments in healthcare organizations could choose their own systems tailored with customized interfaces. However, exchanging data among these customized processing systems proved difficult. During the late 1980s, interface engines and messaging

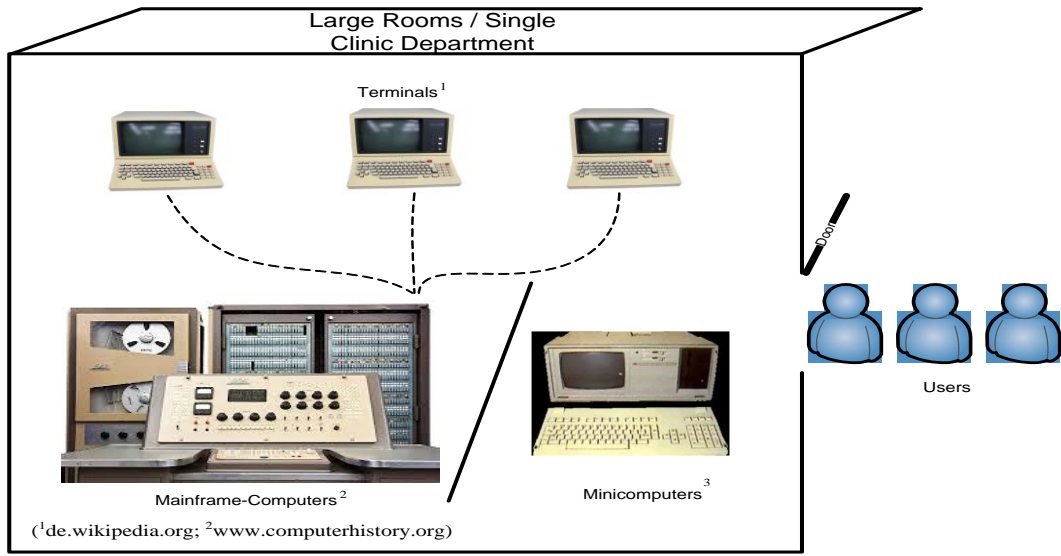

Figure 1 Medical Information System in 1960s~1970s

standards such as Health Level 7 (HL7) and Local Area Network (LAN) were developed to exchange healthcare data between different departments. (See, Figure 2)

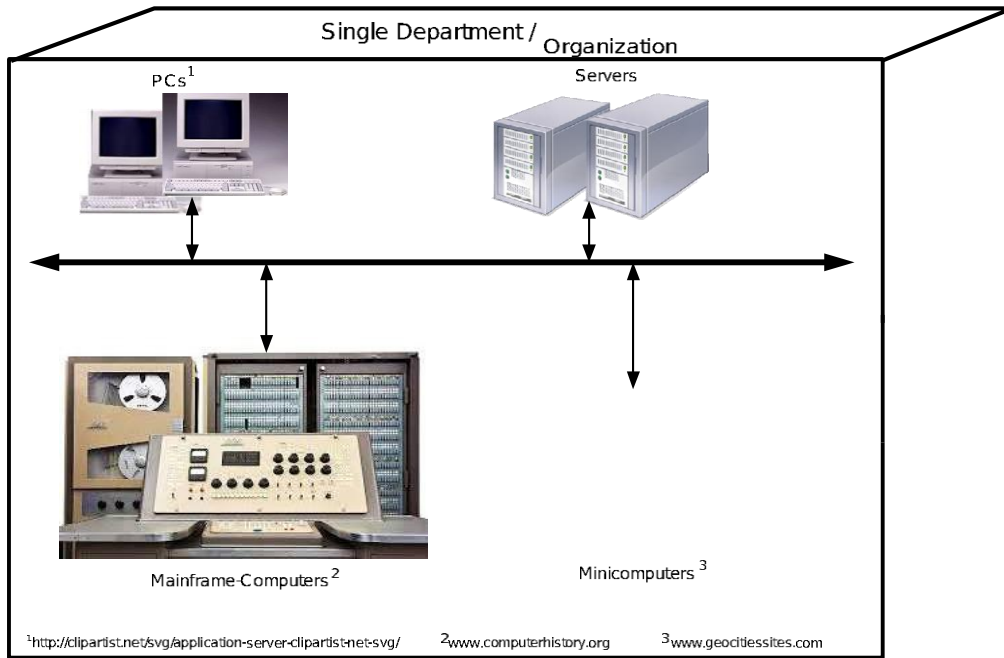

Figure 2 Medical Information System in 1980s

During the 1990s, the Internet enabled single organizational clinical systems to expand to enterprise-wide clinical systems, including clinical data repositories and other related patient information, with data migrating to operational EMRs. These EMR systems allowed healthcare operators to record patient data as well as record medical notes and encounters with patients as single episodes. The EMR systems connected to other systems such as pharmacy systems, diagnostic labs and imaging centers. (See, Figure 3)

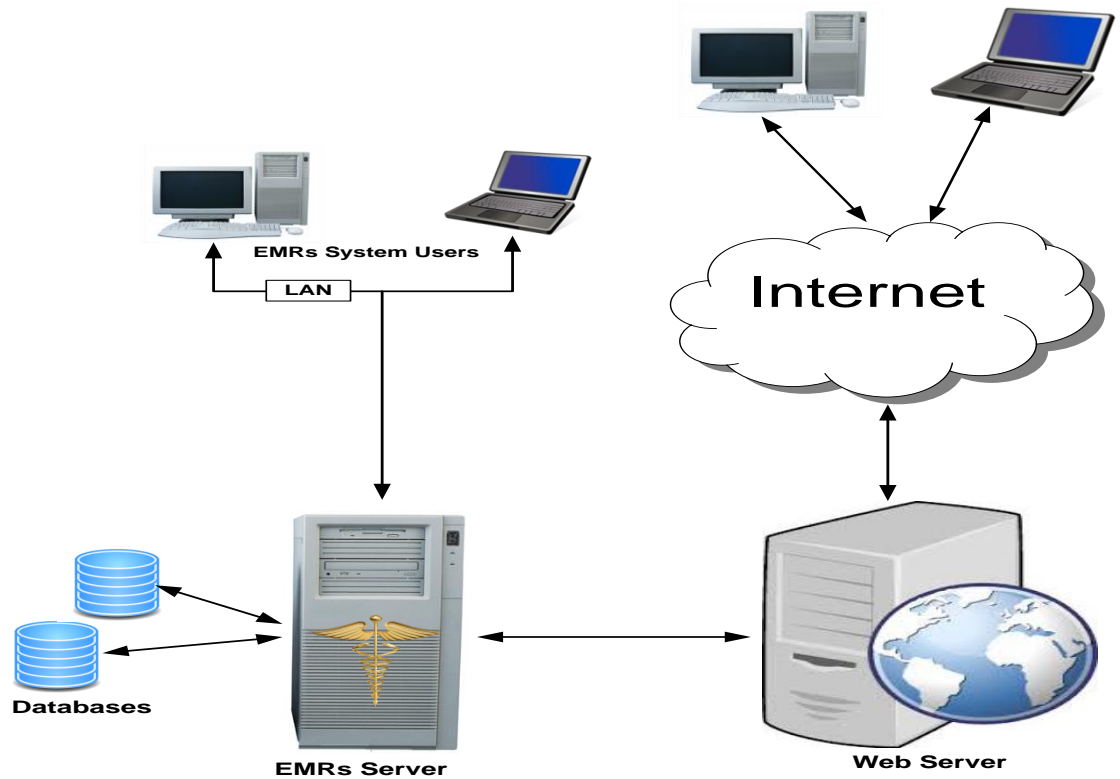

Figure 3 Medical Information System in 1990s

2.2 Architecture of the Workflow-base EMR System

Because medical organizations have over two decades adopted EMR systems that are costly (\$25- \$45 Million for a large hospital), medical organizations are understandably reluctant to switch to new systems. My architecture deals with that by not requiring new, replacement EMR systems; rather, it upgrades existing EMR systems. More specifically, as stated in Chapter 1, I provide workflow-based choreography for procedural treatment regimes and treatment consents through a workflow-based EMR system with informed consent management by extending existing EMR systems. That ensures that, although there will be other components that drive the EMR system, the users will not notice a difference in interaction. (See, Figure 4)

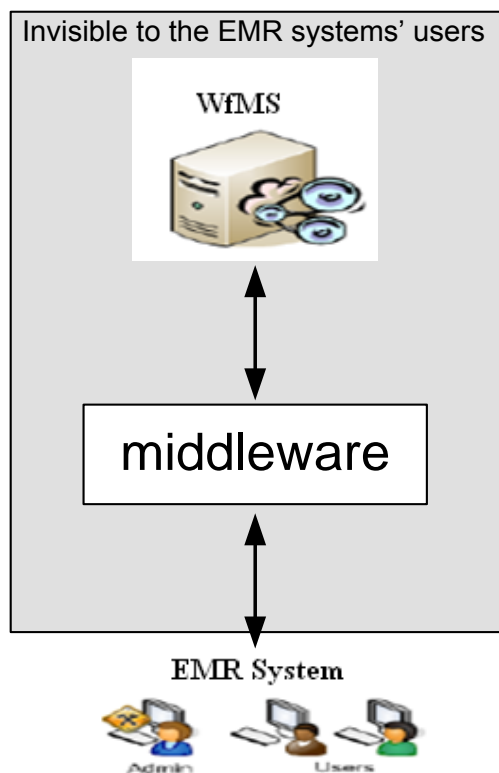

Figure 4 High Level View of Extending EMR System

My first architecture is to enhance an existing EMR system with a workflow management system to choreography predefined procedures. (See, Figure 5)

My system architecture (shown in Figure 5) consists of the following components: (1) User Interface (UI) for EMR system users, (2) EMR's Runtime System, (3) WfMS — Workflow Management System -- a runtime system that enforces medical treatment workflow, and (4) their corresponding databases.

- (1) UI: Enables interactions between the EMR systems and EMR system users (usually refer to humans, such as the medical treatment team, the quality care team who may want to review the logs, etc.)
- (2) EMR System: Provides clinical functions, including the display of patient demographic information, vital signs, medication, lab order/results, etc.
- (3) Workflow Management System: Designs and executes workflow models, consisting of a workflow editor, workflow runtime engine and other components such as a workflow task handler that enforces the completion of a specific task.
- (4) Related Databases: WfMS' databases contain careflow specifications composed of tasks describing treatment processes and WfMS' data; while EMR systems' databases contain patients' medical records and other EMR systems' data.

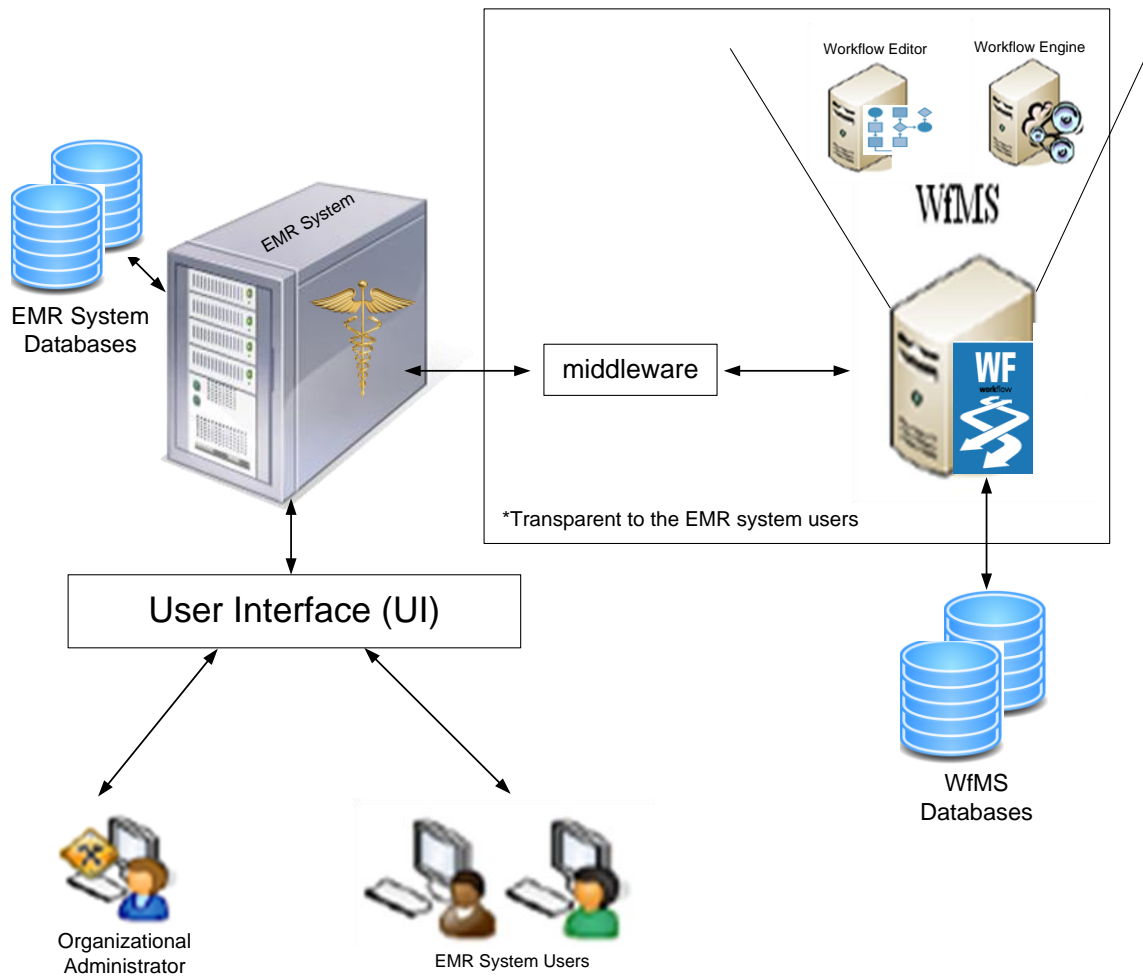

Figure 5 Workflow-based EMR System Architecture

Figure 6 shows the interaction between the WfMS engine and the EMR system.

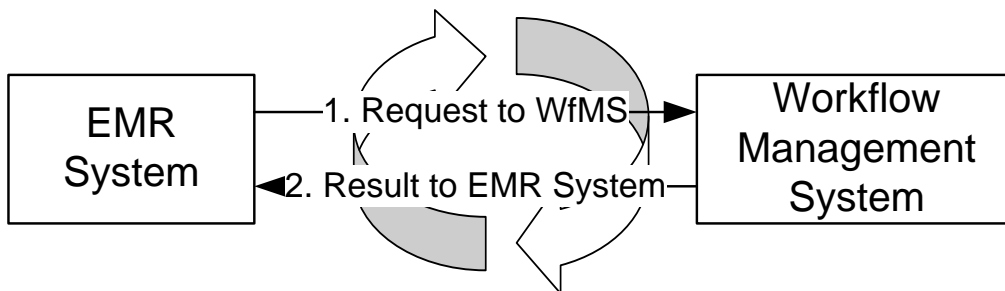

Figure 6 Interactions between the WfMS and EMR System per session

1. *EMR System* → *WfMS (Step 1)*: When a caregiver starts a medical treatment procedure in an EMR system, a “launch case” event request with careflow specification identification (I.D.) or name is sent to WfMS engine; WfMS engine enables some work item(s). Here, case refers to a specific instantiation of a workflow model/workflow specification; work item refers to a task/step.
2. *WfMS (Step 2)*: Enables other appropriate work items based on control flow defined in the workflow specification and input data.
3. *WfMS* → *EMR System (Step 3)*: WfMS sends notification to EMR system. The available work item(s)/step(s) will notify the EMR system’s users via UI. Then, interactions between WfMS and EMR system are repeated.

My second architectural enhancement adds a consent management component, so that the enhanced EMR system is capable of dynamically obtaining required treatment consents.

The system shown in Figure 7 consists of all components of my Workflow-based EMR system, which includes existing EMR systems and the WfMS. In the new architecture, WfMS enforces medical treatment workflow, as well as checks and enforces treatment consents before enabling a workflow. I also added a CMS that ascertains which consents, if any, are missing and must be issued. (See, Figure 8 for the interaction among the WfMS engine, the EMR systems and CMS.)

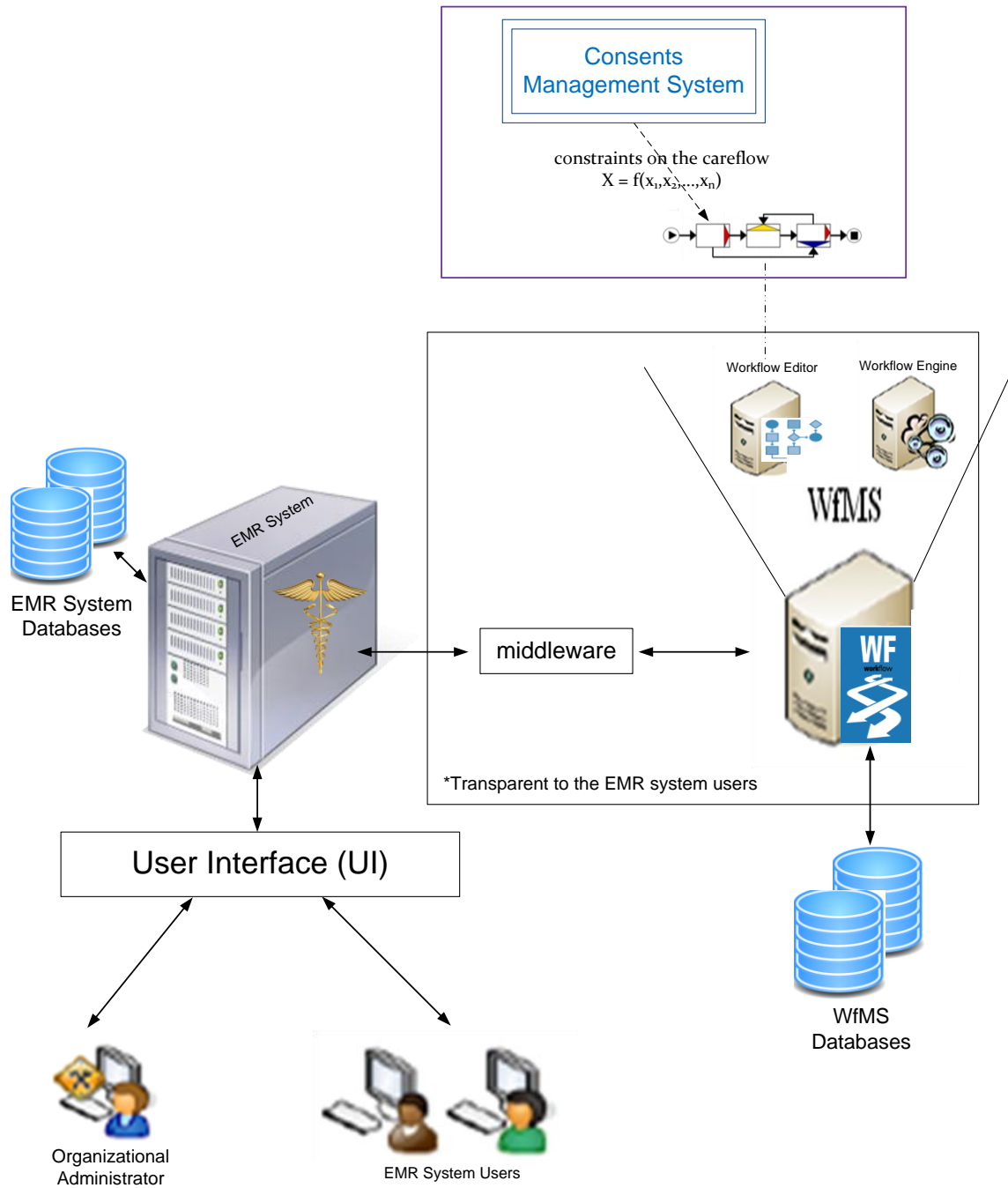

Figure 7 Workflow-based EMR System with Consent Management Architecture

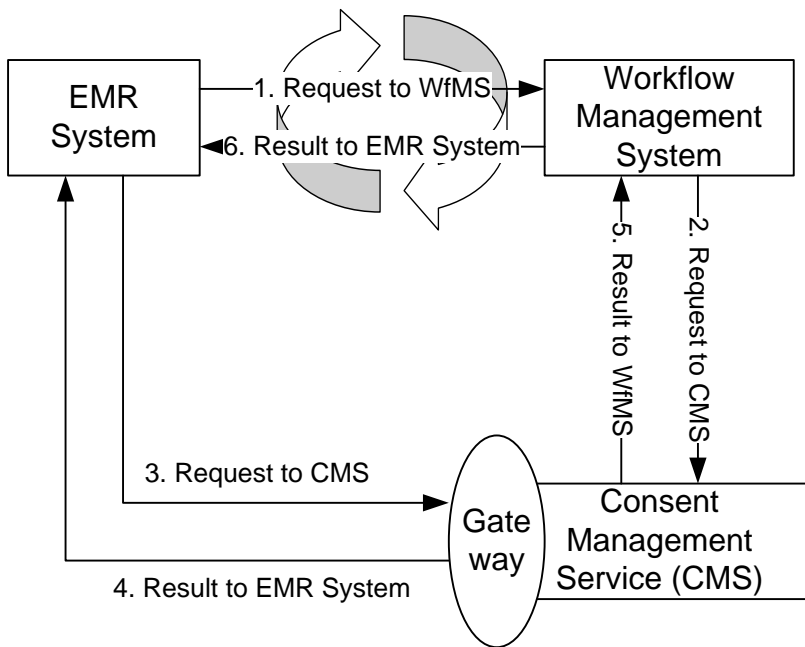

Figure 8 Interactions between the WfMS and EMR System per Session

1. *EMR System* → *WfMS (Step 1)*: When a caregiver starts a medical treatment procedure in an EMR system, a “launch case” event request with careflow specification I.D. or name is sent to WfMS engine; WfMS engine enables some work item(s) based on control flow defined in the workflow specification and input data. If the enabled work item(s) does not request consent service, then go to Step 6. Otherwise,
2. *WfMS* → *CMS (Step 2)*: If a procedure/step needs to check patient’s informed consent, the CMS is triggered.
3. *EMR System* → *CMS (Step 3)*: This additional step exists only when requiring informed consent. EMR system asks CMS what kind of consents should be issued.

4. *CMS → EMR System (Step 4)*: Same as the previous step, this additional step exists only when requiring CMS. CMS returns the answers to EMR System.
5. *CMS → WfMS (Step 5)*: CMS passes results to WfMS, the WfMS decides whether the treatment should continue or be aborted based on the treatment specification and on the patient's treatment decision.
6. *WfMS → EMR System (Step 6)*: WfMS notifies EMR system. Available work item(s)/step(s) will be brought to the attention of EMR system's users using an interface. Then, the interactions between WfMS and EMR system are repeated.

Last, my architectural enhancements use a standardized ontology that can use diverse state laws (alone and in combination) in dynamically generating consent forms (See, Figure 9).

My enhanced workflow-based EMR system architecture shown in Figure 9 includes a Consent Rule Management System connected to an Ontology Service (OS). The Consent Service (CS) generates the appropriate informed consent forms automatically and obtains the consent before passing to the next work item. The ontology service includes ontology editor (to edit terms and rules), a rule set that codifies consent laws and a reasoner that derives consents that are displayed as consent forms by the EMR system.

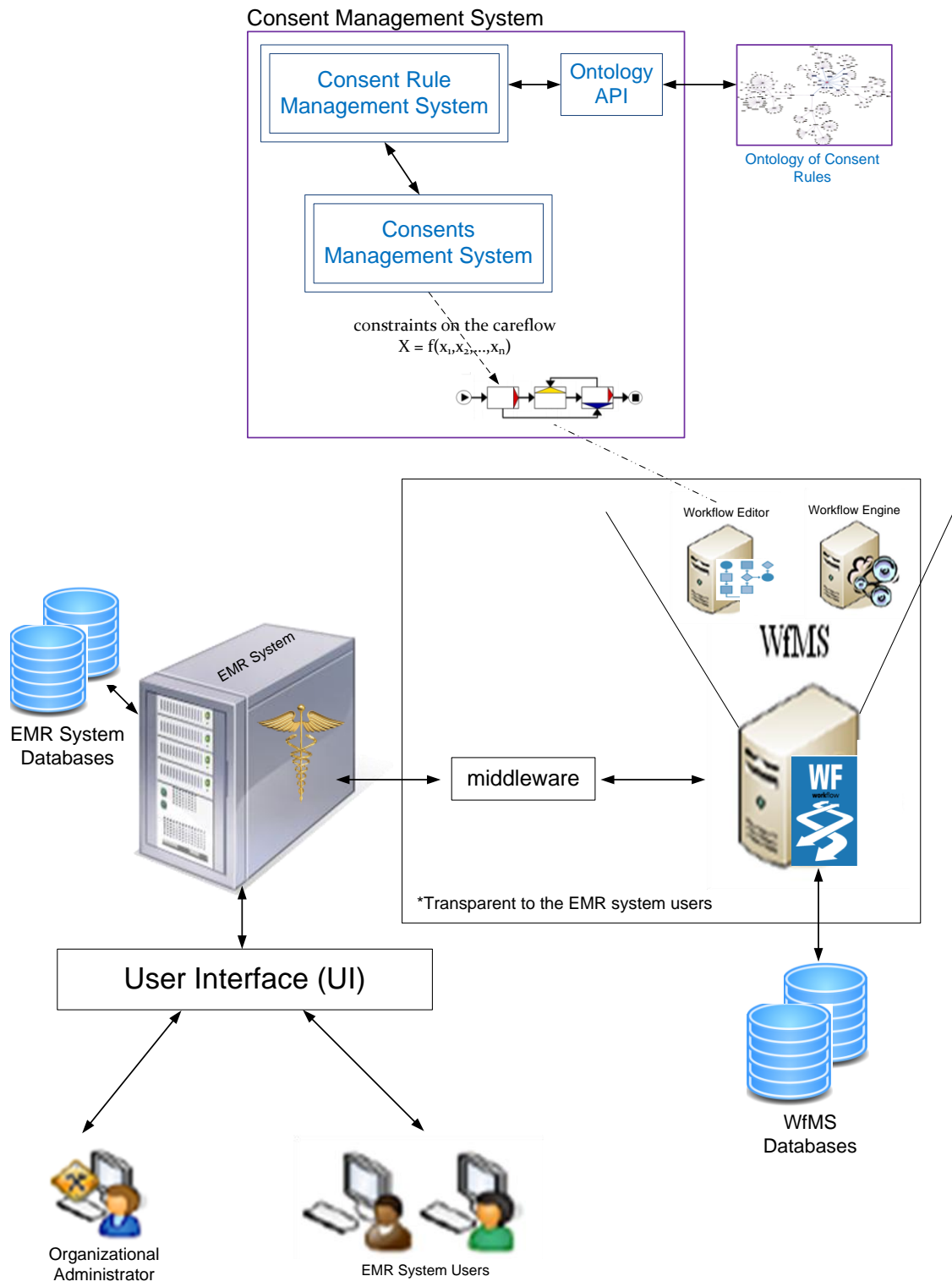

Figure 9 Enhanced Workflow-based EMR System Architecture

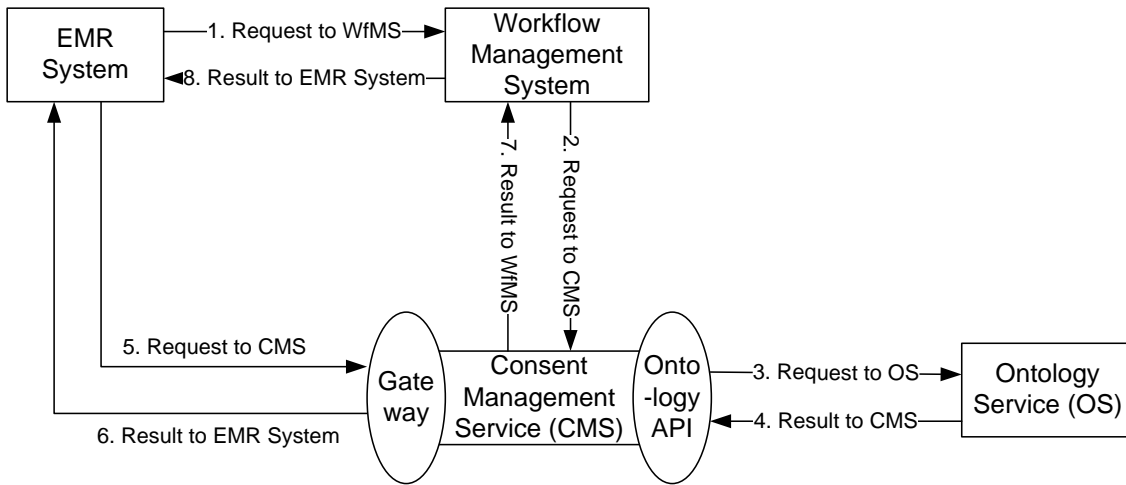

Figure 10 Interactions between the WfMS, the EMR System and CMS per Session

Finally, I describe the interaction among the WfMS engine; the EMR systems; and the CMS and OS. (See, Figure 10)

1. *EMR System* → *WfMS (Step 1)*: When a caregiver starts a medical treatment procedure in an EMR system, a “launch case” event request with careflow specification I.D. or name is sent to WfMS engine; WfMS engine enables some work item(s) based on control flow defined in the workflow specification and input data. If the enabled work item(s) do not request consent service, then go to Step 8. Otherwise,
2. *WfMS* → *CMS (Step 2)*: If a procedure/step needs to check patient’s informed consent, the CMS is triggered.
3. *CMS* → *OS (Step 3)*: CMS uses Ontology Web Language (OWL) API to connect to the OS with patient’s information and other required consent

information. An individual has been created and can use Pellet to reason appropriate outcomes.

4. *OS* → *CMS (Step 4)*: OS returns the results reasoned based on the Semantic Web Rule Language rules to CMS.
5. *EMR System* → *CMS (Step 5)*: This is additional step existing only when requiring informed consent. EMR system asks CMS what kind of consents should be issued.
6. *CMS* → *EMR System (Step 6)*: Same as the previous step, except this step is required only if the consent service is called. CMS returns the answers to EMR System.
7. *CMS* → *WfMS (Step 7)*: CMS passes results to WfMS, the WfMS decides whether treatment should continue or be aborted based on the treatment specification and on the patient's treatment decision.
8. *WfMS* → *EMR System (Step 8)*: WfMS sends notification to EMR system. The available work item(s)/step(s) will notify EMR system users via UI. Then, the interactions between WfMS and EMR system are repeated.

For implementing my framework, I used open source software: YAWL Management System as WfMS; OpenMRS as the EMR system; OWL to describe my consent ontology, implemented in Protégé; and applied Pellet as the ontology reasoner.

CHAPTER THREE WORKFLOW-BASED EMR SYSTEM

3.1 Introduction and Background

As today's healthcare industry pays increasing attention to patient safety, quality of care, risk management and security and privacy preservation of medical data, executives and academics seek quality improvement strategies to provide more standardized, safer and efficient patient services. The U.S government plays a major role in promoting IT for healthcare, especially EMR systems.

In the last several decades, much literature and numerous case studies have addressed many of the goals for improving health care delivery, including integrating standard medical processes with EMR systems for patient safety, monitoring compliance of process and measuring outcomes, improving care management, increasing patient engagement and shared patient-provider decision-making. Therefore, "the current role of researchers in healthcare informatics is twofold: To develop new methodologies that provide required functions in EMR systems; and to connect them seamlessly with existing functions for both clinicians and patients [45]."

Most medical processes are procedure-oriented and are established by specialty boards as practice standards. These consist of activities that caregivers must complete. Usually multiple checks are required by standardized treatment procedures and documented in guidelines. Safety checklists, new policies, guidelines, and standards have

been developed to govern medical procedures in order to help reduce medical errors, improve decision-making, improve medical outcomes and develop more positive caregiver-patient relationships.

Mechanisms of checking for mistakes, or reminding healthcare providers of things they may miss, would decrease morbidity and mortality rates and reduce risk. Ideally, enforcing medical workflows, which string sequences of actions that are required to provide an agreed upon standard of care in existing EMR systems, would take the healthcare team from the first consult through continuous treatment regimens. Attaching a checklist for each such action, or a combination thereof (possibly provided by multiple caregivers) advances the benefits of using checks with medical careflow. Even more, obtaining and recording electronically consents from legally authorized consent providers and enforcing them in workflow-driven EMR systems will improve quality of care and medical outcomes.

However, today's EMR systems do not truly support and enforce pre-defined treatment workflow in run-time. In addition, current research is lacking on EMR systems integrated with treatment workflow management systems. My framework of Workflow-based EMR systems extends the functions of existing EMR systems. It directly controls the progression of predefined and prebuilt care procedures that comply with local or national standards and policies. Moreover, this Workflow-based EMR system also provides flexibility that caregivers need to continue treatment when, in their judgment, superior care compels moving to the next task despite prerequisite tasks not completed as specified in the workflow. Meantime, it is also better suited to study healthcare delivery

safety and quality care issues. Workflow logs perform an ongoing audit trail to satisfy accountability requirements and can also be used to improve the workflow.

Integrating my framework with existing EMR systems should ensure care teams follow treatment plans from one step to another, thereby avoiding the disadvantages and harm from deviation from procedures and policies. It conforms to healthcare industry development trends by improving patient safety and healthcare treatment outcomes, and by tracking safety and its relationship to the utilized workflows.

Next, I will use eye implant surgery as a case study of medical treatment workflow and embedded checks.

3.2 Medical Workflow

Medical workflows/processes generally fall within two categories: Organization workflows and medical treatment workflows. Organizational workflows refer to processes used to coordinate collaborating healthcare professionals and organizational units [48]. Organizational workflows improve medical organization management.

Medical treatment process recommends the appropriate treatment methods, which are steps the care team must follow. Some researchers also call this medical treatment process “medical treatment workflow.” More specifically, medical treatment workflow refers to specialty board-established sequences of procedures reflecting best practices for a specific treatment. Medical treatment workflows guide healthcare teams from first consult through continuous treatment regimens. They improve patient safety and quality of care. Usually safety checks are pre-conditions in the steps of treatment workflow.

I focus herein on medical treatment workflows and support them in existing EMRs by workflow technology.

3.2.1 Medical Treatment Workflow

This sub-section reviews a lens implant surgery case study that I co-developed with an eye surgeon to show a specific cataract surgery treatment workflow where different team members must perform different checks at different steps within the workflow. See, Figure 11 for steps from patient check-in at the hospital until discharge.

Administration Area

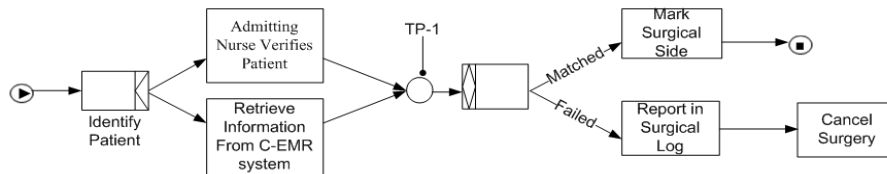

TP-1: After Identified patient, patient is either ready to be transport to Pre-OR holding area or surgery is canceled

Pre-Op Holding Area

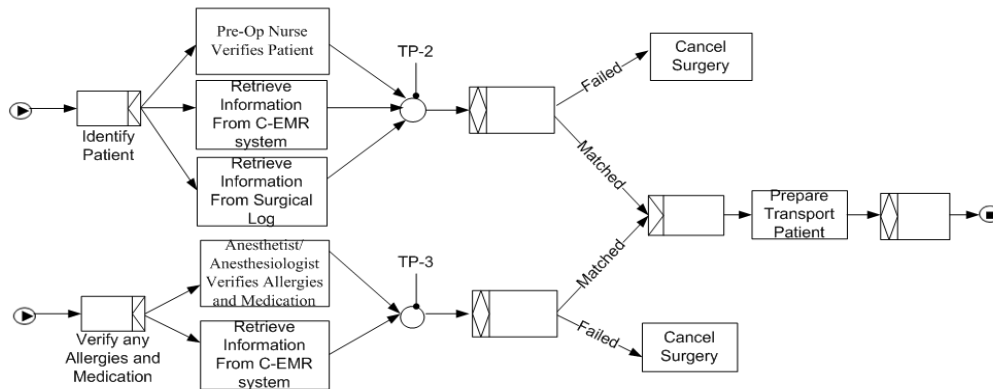

TP-2,TP-3: After Identified patient and verify any allergies and medication, patient is either ready to be transport to OR or surgery is canceled

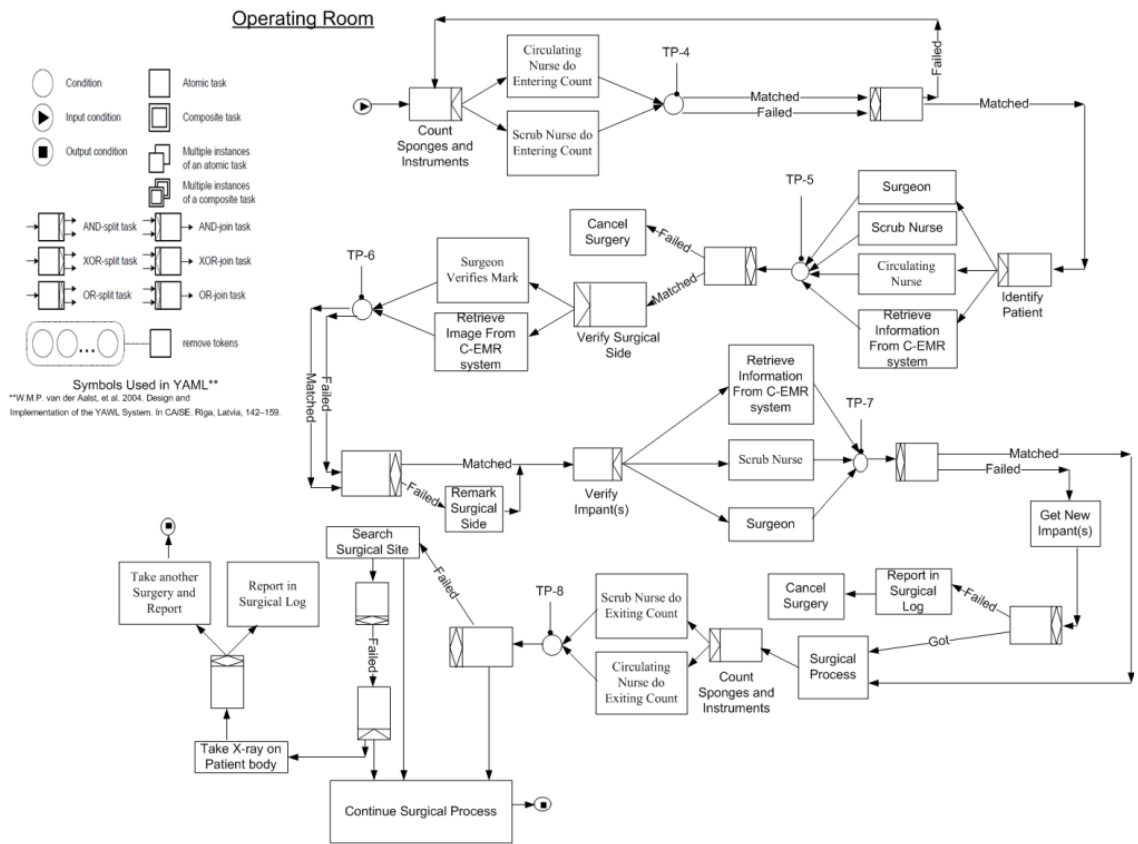

Figure 11 an Example of Medical Treatment Workflow

The steps include: (1) the Admitting Nurse (role) identifies the patient in the EMR system upon arrival at hospital; (2) the Transport Technician (role) transfers the patient to the pre-operative (Pre-Op) holding area; (3) the Anesthetist/Anesthesiologist (role) meets the patient in Pre-Op area to verify any allergies and medications; (4) the Circulating Nurse (role) and the Scrub Nurse (role) prepare the OR; (5) Surgeon (role) checks the marked site/side; (6) the Surgeon (role) starts the surgical procedure; (7) the Circulating Nurse (role), Scrub Nurse (role) and Surgeon (role) verified Implant; (8) The Circulating Nurse (role) and Scrub Nurse (role) count “sponges and instruments” before closing

incision; (9) the Transport Technician (role) transport the patient to the Post-Anesthesia Care Unit (PACU) after surgery is completed; (10) the PACU Nurse (role) accepts the patient upon arrival; and (11) once the patient has recovered, the PACU Nurse (role) discharges the patient from the PACU.

3.2.2 Embedded Checks in Medical Treatment Process

Figure 12 shows lens implant surgery treatment workflow along with a timeline.

Each colored line represents each individual workflow associated with different caregivers (based on role).

The TP shown in Figure 12 is a treatment workflow check referred to as Time-out Point (TP). TP-n denotes the nth time-out point. At that point all caregivers must stop the pre-defined checks embedded in the workflow's steps.

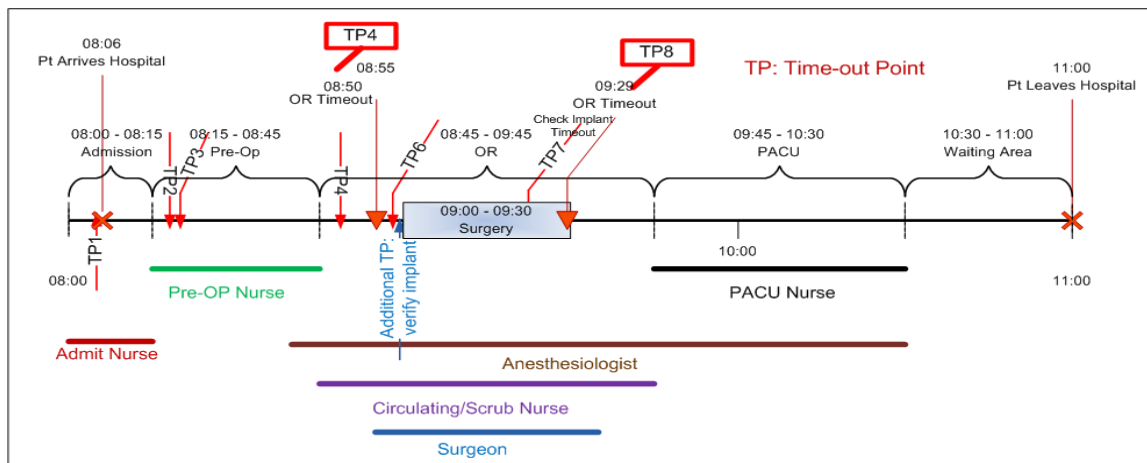

Figure 12 Sample Procedure Timeline (original)

TP1: Admin Nurse identifies patient

TP2: Pre-OP Nurse re-identifies patient

TP3: Anesthesiologist verifies patient's information

TP4: Circulating/Scrub Nurses count sponges, thread and instruments before surgery

TP5: Circulating/Scrub Nurses /Surgeon confirm surgery information before starting surgery

TP6: Surgeon verifies surgery sites

TP7: If implanting, check implant type and requirement

TP8: Circulating/Scrub Nurses count sponges and instruments after surgery

The surgical workflow (See, Figure 11) starts when the Admitting Nurse (role) identifies the patient in the EMR system upon arrival at the hospital. The first time-out point (i.e., TP-1) is required at the beginning. At this step, in order to pass the TP-1, the identifying information needs to match the information in Clinical EMR system (C-EMR). Once the patient is identified, the workflow proceeds to the next stage of wheeling in the patient. If the comparison does not succeed, the Admitting Nurse (role) must communicate with clinic staff to recheck the patient. If the patient is not the correct person, the surgical procedure is canceled.

Then, the Transport Technician (role) transfers the patient to the Pre-Op holding area. The Pre-Op Nurse (role) identifies the patient in the Surgical EMR (S-EMR) system upon arrival. This requires the second time-out point, TP-2. Here, in order to pass the TP-2, the identifying information must match the information in the surgical log in S-EMR and the information in C-EMR. If the comparison does not match, the Pre-Op Nurse (role) must communicate with the Admitting Nurse (role) to re-identify the patient, and again if failed, the surgical procedure is canceled. Additionally, the

Anesthetist/Anesthesiologist (role) must also meet the patient in the Pre-Op area to verify any allergies and medications, and must again re-verify the surgery. This is the third time-out point, TP-3. The verification information needs to match information in C-EMR, in order to pass TP-3. The Anesthetist/Anesthesiologist (role) communicates with clinic staff to verify related information again; if failed, this is a wrong surgery, and the alternative is to cancel the surgery and document it in the surgical log. After Passing TP-2 and TP-3, the patient is ready to be transported to the OR.

The Circulating Nurse (role) helps prepare the OR--placing the sterilized instrument tray and other equipment on sterile tables. The Scrub Nurse (role) unwraps instruments placed on the sterile tables by the Circulating Nurse (role). Both of them must count “sponges and instruments”. The 4th time-out point is defined right here. At this step, in order to pass the TP-4, the checking information given by Circulating Nurse (role) must match Scrub Nurse’s (role). If the counts do not match, the nurses must recount. This is a non-detrimental time-out point. Then the Surgeon (role) sees the patient in the OR. The Circulating Nurse (role) will read the patient’s name, type of surgery, side of surgery before the Anesthetist/Anesthesiologist gives the patient pre-operative sedatives. This is TP-5. Before the surgeon drapes the patient and proceeds with surgery, all information about the surgery read by the Circulating Nurse (role) must be reconfirmed by the Circulating Nurse (role), the Scrub Nurse (role) and the Surgeon (role); it also must match the information in the C-EMR. This is a detrimental TP. For minimizing any error at this stage, the surgical team must carefully adhere to TPs 1, 2, 3. The next time-out point, TP-6, occurs when the Surgeon (role) checks the marked

site/side. The patient's last diagnosis image retrieved from the C-EMR is shown on a screen in OR. In order to pass TP-6, the marked side must match the information on the image. If passed, the Surgeon (role) starts the surgical procedure. The Scrub Nurse (role) assists the surgeon by handing instruments, sutures and implant(s) to the surgeon when needed. The Anesthetist/Anesthesiologist (role) monitors the patient's vital signs throughout the procedure. This monitoring information is automatically stored in a surgical log. Before setting an implant, the point of asking for the implant is TP-7; the implant type, power, etc. is verified from the records and repeated by the Surgeon for verification. If they do not match, the alternatives are: 1) Get new implant; 2) if new implant is not available, cancel surgery; and report this in surgical log. This is a detrimental TP in the treatment workflow. At the end of operation, TP-8 ends the process. The Circulating Nurse (role) and Scrub Nurse (role) count "sponges and instruments" separately and compare with each other. Unlike TP-4, this post-surgical/exiting count may not match the pre-surgical/entering count. Detailed information is described in the last section. At the end of the case, the patient is transported to the PACU.

The Circulating Nurse (role) can also help the Transport Technician (role) transport the patient to the PACU after the surgery is completed. The PACU Nurse (role) accepts the patient upon arrival, monitors the patient during the recovery period, and reports any concerns to the anesthesiologist. The PACU Nurse (role) documents patient status, drinking fluids, vomiting and other clinical observations necessary for discharge. Once the patient has recovered, the PACU Nurse (role) discharges the patient from the

PACU. Discharge orders from the surgeon determine what the patient will do as well as follow-up instructions.

Expressing and analyzing treatment workflow leads to optimizing it. For example, here the implant will be checked for the compatibility before the surgeon inserts it into the eye of the patient. This is a detrimental time-out point, TP-7.

Condition: (observed_implant_type = prescribed_implant_type)

Type: detrimental

Alternatives: {1. Get new implant}

Here the attribute observed_implant_type is observed by the surgeon and/or the circulating nurse. The variable prescribed_implant_type can be obtained from the C-EMR. This TP enforces that if implant types do not match, then abandon the surgery. Although this TP is detrimental, checking that the available implant is type compatible with the prescribed implant type could be moved to the beginning of the surgical procedure because values of both attributes are available at that time. Thus, I can either move this TP to the beginning of the surgery, or insert the same TP at the beginning of the surgical procedure.

3.2.3 Placing Detrimental Time-out as Early as Possible

In this section I describe an algorithm to place detrimental TPs as early as possible:

For each detrimental time-out point, get the stage, say E of the workflow, where all variables of the condition are instantiated.

Create a TP at E and assign the same actors responsibility for checking the condition of the new TP.

This algorithm can be optimized by combining the conditions of multiple detrimental time-out points at one workflow point. This way all “showstopper” issues are addressed at the earliest stage. Because attending to TPs consume valuable time during surgery, combining them eliminates multiple workflow stops.

Another possible optimization is to verify whether the condition of a TP logically implies the condition of a later TP in that workflow because, in that case (unless the attributes change between them), the later time-out may be safely removed. Traditionally, caregivers followed treatment workflows in their routine work that were either learned during training or from documentation. Thus, the workflows were not standardized. Variation led to treatment errors. I try to improve upon current practice given each medical treatment workflow differing from case-to-case.

I am addressing an analysis that necessitates a more detailed specification and consideration of variable mutability during treatment workflow.

A “medical guideline” promotes decisions and criteria regarding diagnosis and treatment in specific healthcare areas, and recommends steps that should be followed and as well as checks. In the US, the National Guideline Clearinghouse maintains a catalog of high-quality guidelines published by various organizations (mostly professional physician organizations). Studies show that using checklists set forth in a guideline increase effectiveness. But such guidelines and checklists are either paper-based or digitally stored

in EMRs that cannot ensure checks have been done at pre-defined treatment workflow points.

3.3 Modeling Complex Treatment Workflows

To verify my Workflow-based EMR system, I used a HD EMR system as the case study to show how to model a treatment workflow and how workflow technologies can integrate with existing EMRs, as well as enforce treatment workflows. I chose HD because HD has well-defined treatment procedures. Dialysis removes waste and excess water from a circulating blood, thereby artificially replacing lost kidney function from renal failure [49]. Two main forms of dialysis are used domestically: HD and Peritoneal Dialysis (PD). HD is performed in a professionally-maintained dialysis unit consisting of a healthcare provider team that includes dialysis technicians, nurses, social workers, dietitians and nephrologists. In [1], according to the U.S. Renal Data System published Annual Data Report of 2009, the U.S. had approximately 367,000 dialysis patients in 2007 with most receiving HD [50]. Please recall that, as mentioned before, a report found that failure to follow dialysis policies or protocols caused many medical errors.

Kidney dialysis would benefit from a specialized EMR: Researchers demonstrated that using an EMR system for dialysis would improve treatment efficacy, save cost and labor [34] and reduce treatment errors [35]. Each avoidable incident drew attention to the dialysis industry's quality of care.

Many different kinds of dialysis EMR systems are used today. *De-facto* workflows have also been used in dialysis units across the United States as well. However, my research revealed that these workflows have not been directly facilitated

and enforced in any EMR systems. The significant benefit provided by enforcing workflow into a dialysis EMR system is delivering systematic management among dialysis processes, the result being quality care improvement.

To create a workflow-enforced HD EMR system, I have worked with a HD center to model HD workflows.

3.3.1 Generate a HD Workflow

The methodology used to generate a HD workflow involves the following steps:

- (1) Interview care providers (e.g. dialysis technicians, nurses, social workers, dietitians and nephrologists etc.) who comprise the dialysis team at an outpatient dialysis center to generate their individual workflows;
- (2) Collect the paper-based documents used to record events and data that are associated with the workflows; and finally
- (3) Combine (1) and (2) to generate a more comprehensive HD workflow. I describe the workflow process used by the dialysis unit in a hierarchical manner. That is, I describe the high-level workflow process first with the caregivers involved in the processes and the data that is exchanged between them during the process of providing care. I then describe sub-processes separately and show how they are connected to overall workflow. After creating complete HD workflow, I re-interviewed care providers to verify the workflows, then refined workflow-based on their comments.

3.3.2 High-Level HD Workflow

3.3.2.1 The YAWL Notation in Brief

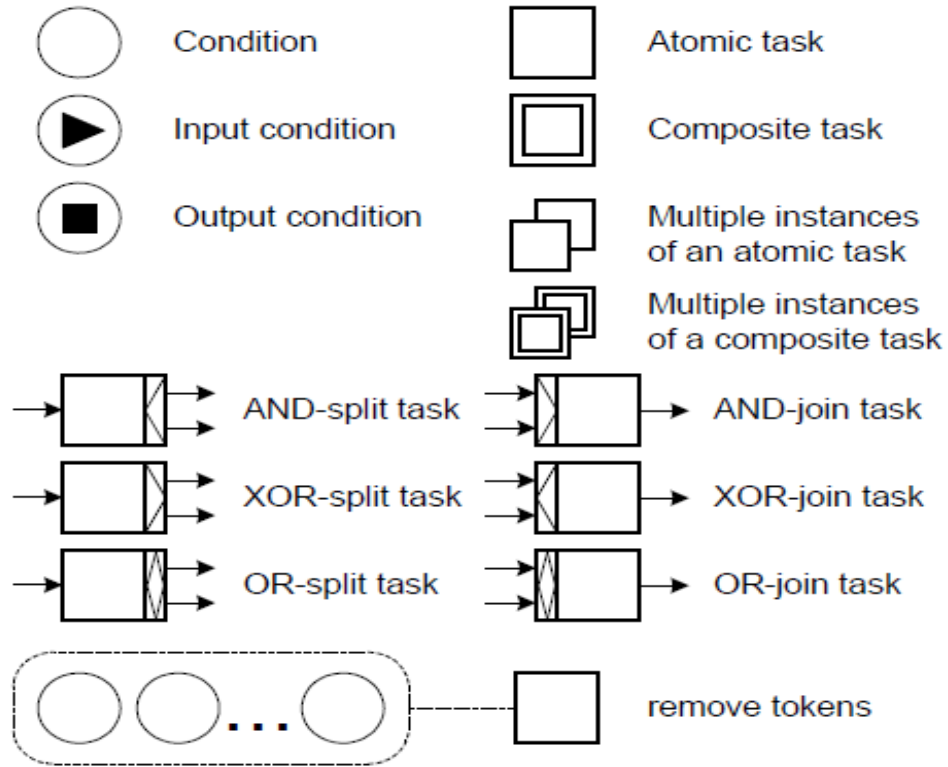

Figure 13 the YAWL Notation













Figure 13 and Table 1 describe the YAWL notations used to create workflows.

The workflows are depicted as a graph where nodes are represented by symbols in Table

1, and arcs are directed arrows that show workflow direction.

Table 1 Symbols Used in YAWL

Name	Symbol	Description
Start Condition		Start of the workflow (mandatory)

End Condition		End of the workflow (mandatory)
Condition		A state for the workflow (also called a Net)
Atomic Task		Represents a single task to be performed by a human participant or an external application
Composite Task		A container for another YAWL process (also called a sub Net)
Multiple Instance Task		Run multiple instances of the same task concurrently
XOR-Split		Used to trigger only one outgoing flow
AND-Split		Trigger more than one task instance simultaneously
OR-Split		Trigger some, but not necessarily all outgoing flows to other tasks
AND-Join		The task can begin when all incoming flows are completed
XOR-Join		The task can begin when at least one incoming flow completes
OR-Join		The task begins either all incoming flows finish, or none of them are known to finish ever
Remove Tokens		Provides the ability to exclude elements from the cancellation set of a task

3.3.2.2 The high-level HD workflow

The high-level HD process, shown modeled using the YAWL editor in Figure 14, covers the lifecycle view of the dialysis process and includes multiple stages. The process begins when the dialysis unit receives a request for long-term HD through mostly

physician referral, the rare exception occurring when a patient contacts the dialysis unit directly.

In describing high-level workflow, the letter W followed by an integer refers to nodes that, by themselves, consist of other workflows. The sub-workflows are written as W.n (where n is an integer).

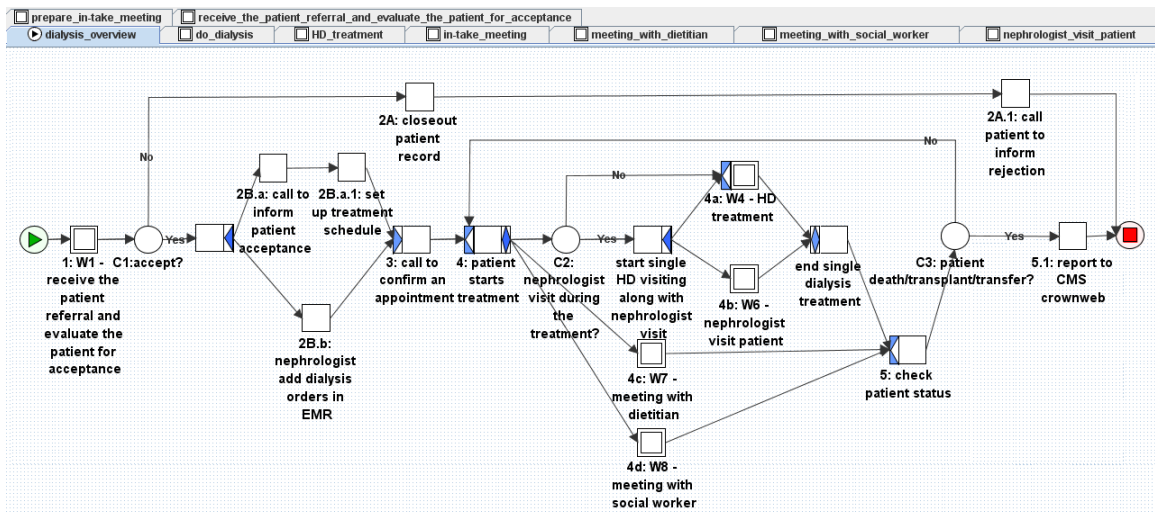

Figure 14 the High-Level HD Workflow

1. **Step 1 with workflow W1:** (Social Worker) Receive the patient referral and evaluate the patient for acceptance. The evaluation is a sub-process. The outcome of this process is the accept/reject decision labeled C1.
2. **C1:** Outcome of the acceptance decision.
3. **Steps 2A or 2B (2B.a and 2B.b) (Mutually exclusive):** The Social Worker communicating the acceptance decisions to the patient via phone (2B accept, 2A reject). (Nephrologist) enter a dialysis order and other

special orders (if any) for accepted patients (**Step 2B.b**) and (Social Worker) schedule treatment visits (**Step 2B.a.1**).

4. **Step 3:** This step can be taken only after a dialysis order has been given and a treatment schedule has been established.
5. **Step 4 (Consisting of many sub-steps):** (Dietician, Social worker and optionally the Nephrologist) An accepted patient starts treatment by visiting multiple healthcare workers who have their own workflows (described shortly).
 - a. **Sub Step 4a with workflow W4:** (Dialysis Technician) HD treatment. Represents a sub-process of HD treatment in the dialysis unit.
 - b. **Sub Step 4b with workflow W6:** (Dialysis Technician, Nurse, Nephrologist) Nephrologists must visit the patient four times per month while undergoing HD treatment.
 - c. **Sub Step 4c with workflow W7:** (Dietician) Meet with the Dietician. This sub-process starts when a Dietician is assigned to work with a new patient.
 - d. **Sub Step 4d with workflow W8:** (Social worker) Meet with the Social Worker. This sub-process starts when a Social Worker is assigned to work with a new patient.
 - e. **Ends a HD treatment:**
6. **Step 5:** (Nurse/Nephrologist) check patient status.

7. **Otherwise:** If the patient continues, repeat HD treatment starting from Step 4. The next sub-section describes the details of one sub-workflow:
 - a. **Condition C 3:** (Patient “lost” or continues)
 - b. **Step 5.1:** If the patient is lost (due to kidney transplant, death or transfer), report the patient as inactive in the dialysis EMR.

3.3.2.3 “Do Hemodialysis” Sub-workflow

This working process (called “*do dialysis*” and named W5) describes all steps taken during HD treatment. During each treatment, the Treatment Nurse must pre-assess the patient for suitability and, if the Treatment Nurse finds an abnormality, will report the observations to the Charge Nurse, and either the Charge or Treatment Nurse calls the Nephrologist as needed. The Nephrologist gives instruction based on the information supplied by the Charge Nurse. These instructions may or may not become orders. For example, if a patient has fever, the Nephrologist would order blood cultures and prescribe antibiotics. If the patient falls, the Nurse checks the patient, finds the status to be satisfactory, and asks the Nephrologist’s permission to send the patient home. In addition, the Treatment Nurse also checks if there is any request for education and whether lab work is necessary; if so, these are done during this visit.

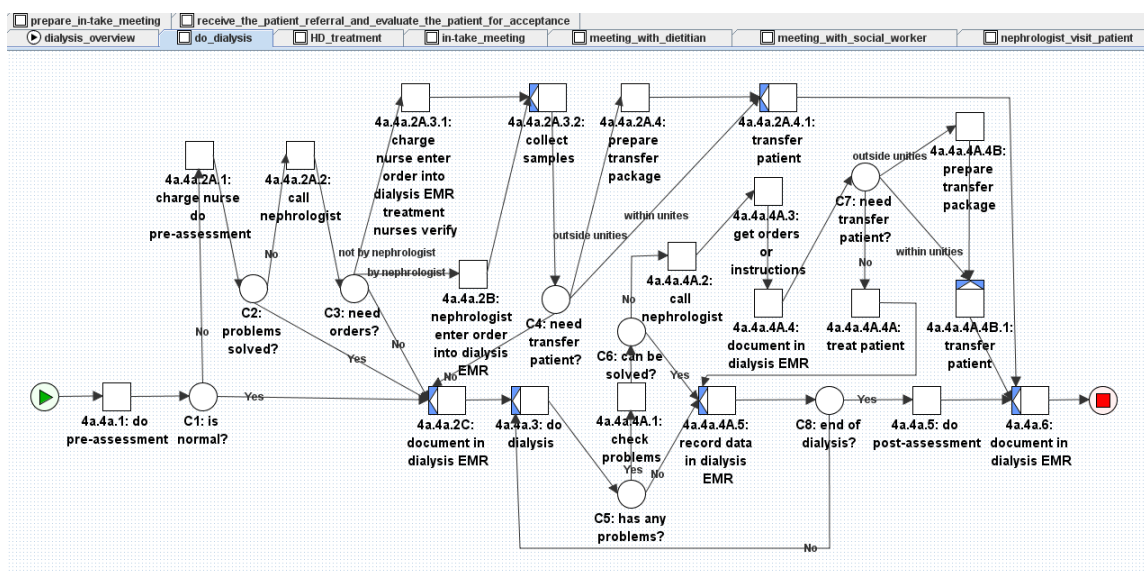

Figure 15 the HD Process

1. **Step 4a.4a.1:** (Treatment Nurse) Pre-assess the patient and document in the dialysis EMR. If abnormality is detected, inform the Charge Nurse or go to Step 4a.4a.2A.2.
 - a. **Step 4a.4a.2A.1:** (Charge Nurse) If needed, pre-assess the patient. If some abnormality can be resolved, document this in the dialysis EMR (**Step 4a.4a.2C**). If some abnormality is observed such as infection, clotted, etc., take the following steps.
 - b. **Step 4a.4a.2A.2:** (Treatment Nurse or Charge Nurse) Call the Nephrologist, for advice if they cannot solve the problems.
 - c. **Step 4a.4a.2A.3:** (Treatment Nurse or Charge Nurse) Obtain orders or advice from the Nephrologist. If ordered, record orders, and the Treatment Nurse acknowledges them.

- i. **Step 4a.4a.2A.3.1:** If Nephrologist is unavailable to enter orders into the dialysis EMR, Charge Nurse inputs them into dialysis EMR and Treatment Nurses acknowledges them. The Nephrologist will “counter-sign” them in the dialysis EMR later.
 - ii. **Step 4a.4a.2A.3.2 (optional):** (Treatment Nurse) If ordered, collect lab samples.
 - d. **Step 4a.4a.2A.4 (optional):** (Treatment Nurse) If needed, prepare and fax a transfer package.
 - i. **Step 4a.4a.2A.4.1 (optional):** Transfer patient
 - ii. **Step 4a.4a.6:** If patient has been transferred, document in the dialysis EMR
 - e. **Step 4a.4a.2B:** (Nephrologist) If available, will enter orders into the dialysis EMR
 - f. **Step 4a.4a.2C:** If patient pre-assessment is normal; or the problems have been resolved; or do not need Nephrologist’s order; or transfer patient, document in the dialysis EMR.
- 2. **Step 4a.4a.3:** (Treatment Nurse) Start dialysis.
- 3. **Condition C 5:** Any abnormality requiring attention?
- 4. **Step 4a.4a.4A.1:** (Treatment Nurse) Check the type of the abnormality. If it cannot be resolved, do the following:
 - a. **Step 4a.4a.4A.2 (If C6):** (Charge Nurse) Describe symptoms and the test results to the Nephrologist.

- b. **Step 4a.4a.4A.3:** (Charge Nurse) Get orders or instructions from the Nephrologist (enter into the dialysis EMR either by Charge Nurse or Nephrologist).
 - c. **Step 4a.4a.4A.4:** Document it in the dialysis EMR.
 - i. **Step 4a.4a.4A.4A (If C7):** If advised to treat in-house, follow advice.
 - ii. **Step 4a.4a.4A.5:** (Treatment Nurse) Record data in the dialysis EMR.
 - iii. **Step 4a.4a.4A.4B (If C7):** If advised to transfer patient, prepare transfer package and fax (if needed).
 - iv. **Step 4a.4a.4A.4B.1:** Transfer patient
 - v. **Step 4a.4a.6:** If patient has been transferred, document in the dialysis EMR
 - d. **Step 4a.4a.6:** (Treatment Nurse) Record data in the dialysis EMR.
5. **Step 4a.4a.4A.5 (No abnormalities or can be resolved):** (Treatment Nurse) Record data in dialysis EMR.
 6. **Step 4a.4a.5 (C8):** If end of the single dialysis treatment, (Treatment Nurse) performs a post-dialysis assessment before discharging patient. The sub-steps will be the similar as pre-dialysis assessment if any situations arise. Otherwise, continue dialysis. Dialysis machine records treatment data into dialysis EMR every 30 minutes.
 7. **Step 4a.4a.7:** (Treatment Nurse) End a single dialysis and treatment.

8. **Step 4a.4b:** (Treatment Nurse) If needed, educate patient on issues such as “emergency disconnect procedure”
9. **Step 4a.4c:** (Treatment Nurse) If ordered, collect lab test samples.
10. **Step 4a.5:** (Treatment Nurse) End dialysis and discharge patient.

3.3.3 Create Workflow Enforced HD EMR

Now I describe how I created a workflow-enforcing EMR system for HD.

I chose YAWL as the workflow management system for multiple reasons. First, YAWL workflow system has been used to implement many workflows in industry and academia. Second, YAWL uses a domain independent syntax to specify workflows, and provides an editor and a runtime engine that enforce workflows specified in YAWL syntax for any applications, allowing audited and verification against regulation by third-parties for workflow accuracy. Third, YAWL is open source. Last, many research projects have recently used YAWL as a workflow-modeling tool.

I chose OpenMRS as the EMR system for two reasons. First, it is an operational open-source EMR system used by many medical facilities and hospitals world-wide. Second, OpenMRS has been designed to act as an extensible platform for EMR researchers to adapt and add desired features [52].

Figure 16 shows high-level system components.

YAWL editor is a workflow specification design tool that sets forth HD process tasks. After launching a workflow specification, the YAWL engine controls the order of task execution and manages data flow (data input, output) associated with each task. However, YAWL engine does not actually execute the task.

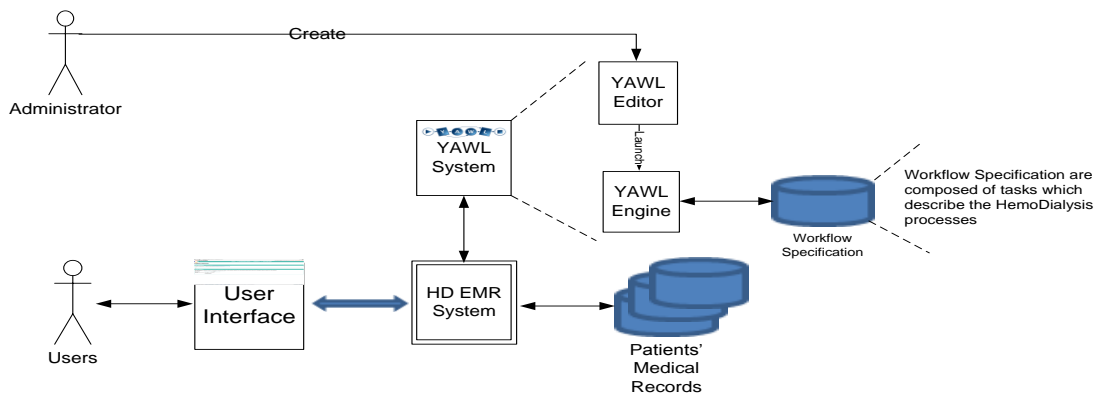

Figure 16 the Architecture of Workflow Enforced HD EMR System

The OpenMRS user community interacts with EMR systems using the well-designed OpenMRS UIs. OpenMRS' databases store all patient data. The dialysis workflow user interface is represented as its own tab in the Patient Dashboard of OpenMRS (See, Figure 17) and incorporates the dialysis unit's organizational and operational knowledge of the HD process as a YAWL specification. The interaction between the dialysis workflow module and the YAWL workflow engine uses a XML/HTTP messaging protocol. (I describe how they interact in more detail later.) To interact, OpenMRS must be able to extend with the ability to:

1. Receive notification from workflow engine and act upon the contents;
2. Inform engine that the active task has been checked;
3. Perform specified tasks; and
4. Inform any workflow engine that OpenMRS has completed a task.

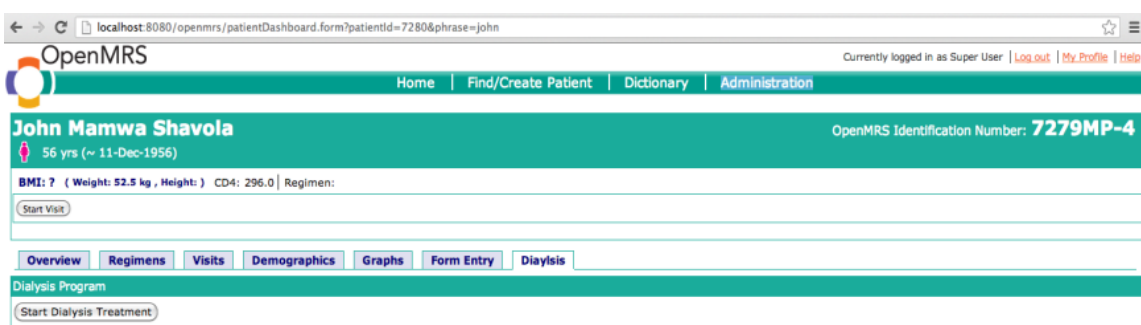

Figure 17 Dialysis Integration in the OpenMRS

I enable use of XML/HTTP messaging protocol by registering the custom designed HD service with the YAWL engine that treats the OpenMRS system as an external controllable service. The customized HD workflow service implements and audits each task by querying each task from the YAWL workflow engine, dynamically creating and presenting the user with the data input and output form required for each task that looks very similar to paper-based forms used in dialysis units, but validates user input before submitting back to the YAWL engine. The YAWL workflow engine uses these specifications to provide caregivers the ability to progress through the treatment steps required to provide dialysis care as specified by the dialysis unit’s policies and procedures.

Figure 18 describes the interaction between the WfMS engine and the EMR system using “*do dialysis*” sub-workflow as an example.

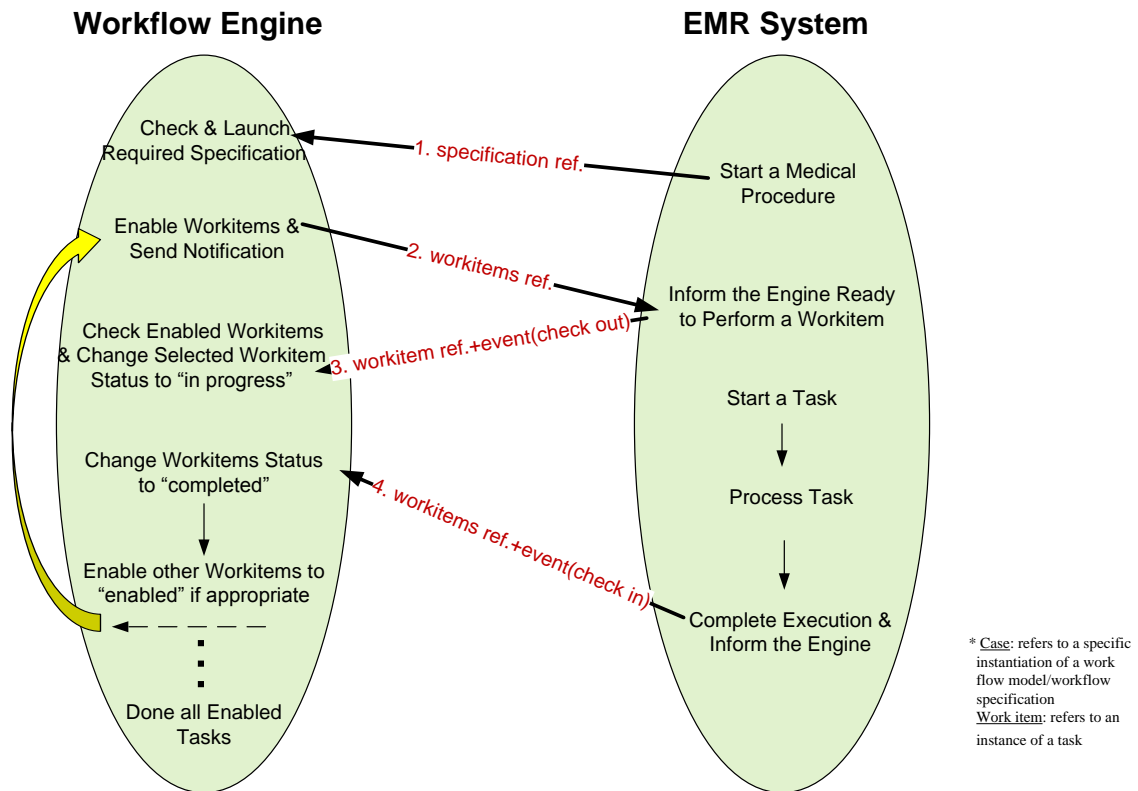

Figure 18 WfMS – EMR system Interaction (per session, implemented using YAWL engine)

- 1) EMR System → WfMS Engine: When a caregiver starts a dialysis treatment procedure in EMR System, a “launch case” event request with workflow specification I.D. or name is sent to WfMS engine.
- 2) WfMS engine → EMR System: WfMS engine launches specified case, checks and changes appropriate work item(s) to “enable”, then notifies EMR System with work items reference, such as case I.D., name, specification identifiers, and so on.
- 3) EMR System → WfMS engine: EMR system uses the referenced work items from Step (2) to inform WfMS engine that EMR system is ready to

execute one enabled work item. This event is also called “check out.”

WfMS engine changes the status of the checked-out work item into “in progress.”

EMR System: (Healthcare personnel) execute the activities of checked-out work item (task)

- 4) OpenMRS → WfMS engine: EMR system informs WfMS engine that the checked-out work item is completed. This event is called “check-in.” WfMS engine changes the status of checked work item to “completed.”

WfMS engine: WfMS engine enables other appropriate work items based on control flow defined in the workflow specification, and notifies EMR System. Then, WfMS engine and EMR system interactions are repeated.

In more detail, I use the sub-workflow “*do dialysis*” generated in section 3.3.2.3 as an example; the following is the HD workflow implementation in OpenMRS:

The care providers select a patient (as shown in Figure 19) after a successful login to OpenMRS.

1. After enrolling a patient and launching the dialysis workflow, the system automatically loads the first task “*do pre-assessment*” into the OpenMRS user interface as shown in Figure 20. Notice that the *Enrollment Date* and *Started By* are displayed in my Graphic User Interface (GUI).

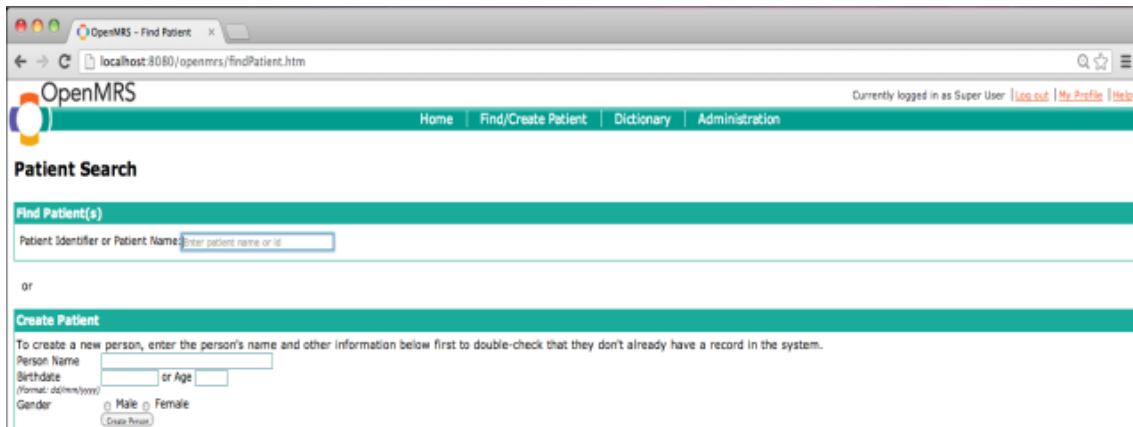

Figure 19 Find a Patient from OpenMRS System

2. After completing Task 1, care providers are allowed to start the sub workflow “do dialysis.” Then a form for the first task of “do dialysis”, “do pre-assessment”, pops-up, requesting information such as patient’s cardiovascular, respiration, accesses. (See, Figure 21) After finishing the pre-assessment task, the care provider clicks the choice box “patient_assessment_ok”, which causes the WfMS to check whether the information is complete and, if so, proceed to the next step.

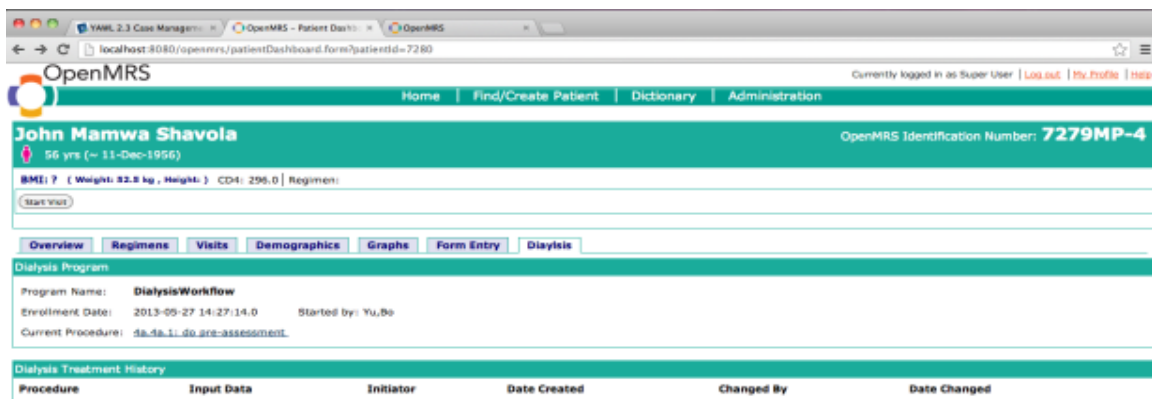

Figure 20 Care Provider Starts a “Do Dialysis” Workflow

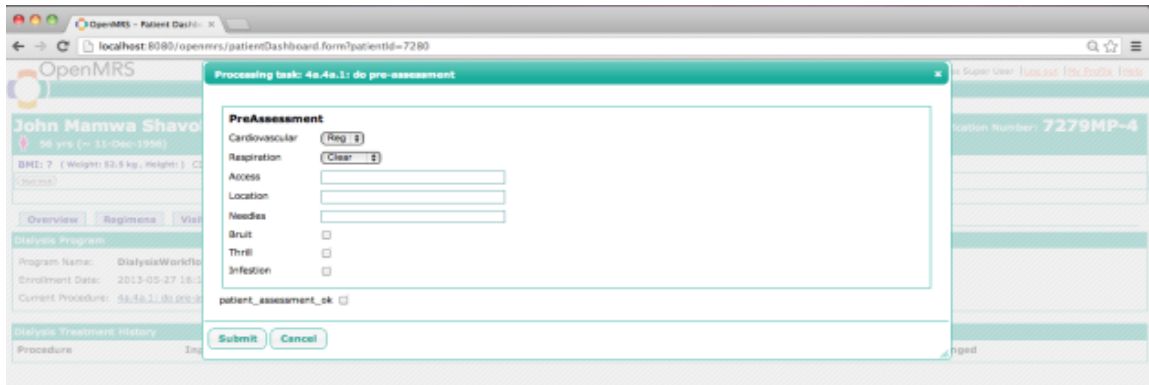

Figure 21 Workflow Inquire Data Form

For example, if the patient’s pre-assessment is abnormal, as shown in Figure 22, the workflow management system will choose the task “charge nurse do pre-assessment” as shown in Figure 23; otherwise, the task “document in flow sheet” is triggered. While executing the specified HD workflow, the workflow management system will automatically fill into tasks information that is already available in the EMR system. The system completes these tasks without requiring human labor and associated time.

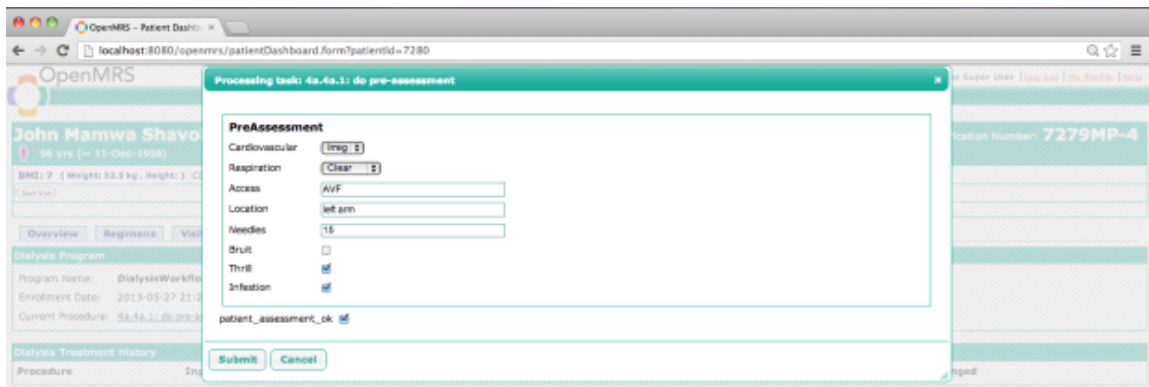

Figure 22 Patient Pre-Assessment Abnormal

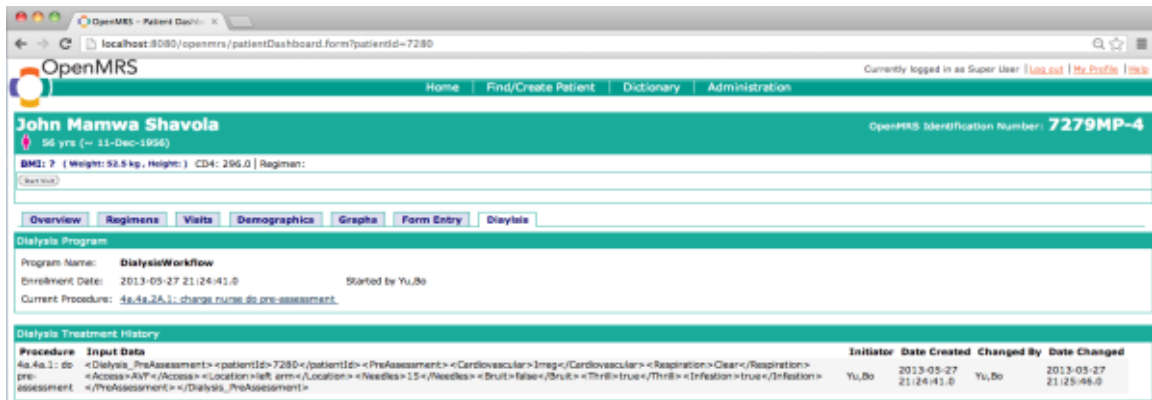

Figure 23 Trigger Charge Nurse “Do Pre-Assessment” Task

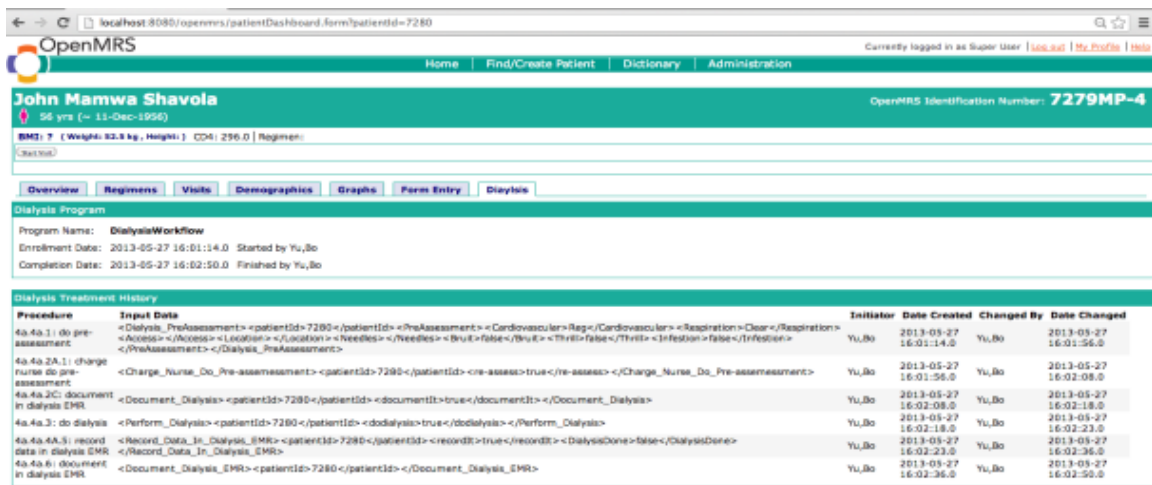

Figure 24 Finished a “do dialysis” Workflow

When the entire “do dialysis” workflow, including all tasks and sub-workflows, are finished the system will display all executed tasks in execution order as shown in Figure 24.

3.3.4 Evaluation and Conclusion

My documented HD workflows embedded in enhanced OpenMRS systems will compel care procedures that comply with local or nation standards and policies.

Workflow-enforced HD EMR systems also allow care providers to bypass unfinished tasks and move the workflow forward when encountering applicable, allowable exceptions. Such design increases EMR system flexibility consistent with complex medical treatment process requirements.

To promote workflow-based EMR system adaptability, I migrated as many tasks as possible into automatic tasks when creating workflow specifications. In addition, I also incorporated a suggestion by Kurtz, which is that a well-designed system should contain sufficient redundancy to minimize the risk of system downtime or data loss [53]. Finally, I paid particular attention to privacy and security issues, which are key issues for any EMR.

1. Access Control: The HD team as a whole provides the required services to a dialysis patient at the dialysis center during regularly scheduled dialysis visits, from acceptance of a patient to completing the last dialysis treatment at the unit. Each team member plays a designated role in providing care per assigned, choreographed duties, forming workflows. The team together provides the care planned for the dialysis patient. I have used a role-based access control model to provide information confidentiality.
2. Accountability: To monitor quality of care, a dialysis EMR system should have auditing capabilities. Our proposed workflow-enforced HD EMR system uses workflow logs for the quality care team to review both procedures and outcomes. It creates an ongoing audit trail so crucial to

accountability, quality assurance, and continuous improvement.

This case study shows a workflow-enforced HD EMR system that is executable; conforms to dialysis industry development trends; complies with an organization's requirements and governing regulations and policies; enables ready accountability and quality assurance; and promotes continuous improvement. It will improve tracking of clinical HD outcomes, safety and their relationship to the utilized workflows. Therefore, system can orchestrate mandated workflow requirements expressed in natural language as clinical best practices and operating manuals using generic workflow control methods in existing EMR system.

CHAPTER FOUR CONSENT-BASED WORKFLOW CONTROL

4.1 Background and Related Works

The term “informed consent,” first used by a California appeals court in 1957 [54], has become a mandatory healthcare practice. Medical informed consent falls mainly into two categories: (1) Consent for information disclosure; and (2) consent for medical treatment. My work herein addresses only treatment consent, with examples for procedure-oriented treatment regimes.

Patients showing up at, or requesting diagnosis or treatment from, healthcare providers constitutes default consent in some instances for certain treatments. In others, the patient, legal guardian or person seeking medical services must expressly provide consent and sign a document memorializing the consent. To enforce consent requirements, EMR systems must be able to condition grant permissions upon prior receipt of valid, appropriate consent.

Informed patient consent—either express or derived—is an important aspect of proper medical treatment, including but not limited to undertaking alternative treatments or terminating treatment. That process includes providing, in an unbiased manner, a risk/benefit analysis; explaining alternative treatments in a way that the patient understands; accurately communicating the care provider’s understanding of the appropriateness of the treatment; advantages and disadvantages of obtaining the treatment

or not obtaining it; and available alternatives [55]. The informed aspect of consent requires care receiver awareness of what he/she is consenting to, and does so willingly without undue influence by caregivers, insurers, or other external pressures. A further requirement is the caregiver's acknowledgment that the patient and/or the guardian has mental capacity to provide such consent. (This makes psychiatric consents and consent given under anesthesia particularly difficult to handle properly.) Over the years, many federal, state, local governments have developed laws and regulations, and healthcare organizations have developed guidelines, for obtaining and memorializing informed consent. Traditionally, the care seeker or his/her legal consent holder signs these consent forms.

In the past decade, consent management has received considerable attention from researchers and healthcare organizations who proposed different ways to improve electronic consent management system. Many publications proposed different ways to improve electronic consent management systems. For instance, "eConsent: The Design and Implementation of Consumer Consent Mechanisms in an Electronic Environment" [56] provided guidelines on how to design an e-consent system. Another relevant work is by Ruan C. & Yeo S.S. [57], who used the UML Model to design an e-consent system. They first identify various parts necessary to specify the e-Consent rules about patient record protection, and then used UML to model the properties required by an e-consent system and to make the associated patient record protection rules explicit and verifiable. However, that work was theoretical; they neither designed nor implemented a system that works with EMR systems.

Rusello G. et al. proposed consent-based workflows for healthcare management [58] where patients can control disclosure of their medical data based on workflows that are related to inter-institution transfers such as consults. Yet, this work does not address workflows for procedure-oriented treatment regimes, treating consent contents as black boxes. Others have proposed e-consent management to be integrated with EMR or electronic health records systems [59-62]. Win et al. in their paper “Implementing patients consent in electronic health record systems” [63] expressed patient consent using an interface-based approach. However, those e-consent approaches focus mainly on sharing medical data, privacy, and security aspects [64-65], but not the complicated nature of treatments.

Many healthcare organizations attempted to have electronic consent management in their EMR systems. Veterans Administration Medical Centers use iMedConsent™ [66] that supports electronic access, completion, signing and storage of informed consent forms and advance directives. iMedConsent has two parts: software application and clinical content library. It generates consents on each procedure without workflows. Nonetheless, the system neither dynamically gains informed consents at the point of providing treatments nor enforces consents on medical procedures.

4.2 Consent Enforcement in Workflow-based EMR System

Still using HD EMR systems as the study case, I added the CMS that, pursuant to governmental and organizational rules and policies, obtains and enforces informed consent for procedure-oriented treatment regimes. In my system, consents are issued electronically using the EMR interface and enforced using the workflow management

system at runtime. My enforcement mechanism enables workflows only after appropriate consents are provided, where the consent will enable or disable the treatment, and in their absence will enable caregivers to follow procedures arising out of exceptions to consents. Consents can alter corresponding medical procedures dynamically.

4.3 Creating Consent Enforcement Mechanisms in Workflow-based EMRs

I leverage the fact that medical consents accompany medical procedures when I developed a CMS and integrated it with Workflow-based EMR system. The best way to implement such a system is by incorporating a medical consent management component into a Workflow-based EMR system. Without changing the Workflow-based EMR system architecture, I created a CMS as an additional component. The consents obtained by my CMS are stored in the EMR as part of patient medical records. I designed additional user interfaces for users to issue missing but required treatment consents. See Chapter 2 for more system architecture information.

I examined many paper-based consent forms and found that they include many attributes. Table 2 shows 21 attributes in 8 dialysis consent forms. Dialysis treatment also uses Advance Directives that provide *Do Not Resuscitate (DNR)* and *Do Not Intubate (DNI)* directives to the Dialysis care team. Table 3 shows 17 attributes used in three Sample Advance Directives consent forms; Health Care Proxies are also relevant for Dialysis treatments because the “proxy” is the person designated by the patient to provide, withdraw or change consents. Table 4 shows a sample of nine proxy forms using 18 attributes.

I summarize different consent form attributes into three main components:

1. Informed consent giver: Person with the legal right to make healthcare decisions, such as parents or legal guardians of minors, proxies, healthcare providers or third-parties.
2. Treatment procedure information: At a minimum, includes procedure benefits, risks and alternative procedures.
3. Patient's decision regarding treatment: Includes the decision (deny or accept) by providing all required conditions and attributes such as signatures, date, etc.

Consents must be based on all input variables, such as consent giver, treatment specification (name, description, benefits, risks, alternatives, etc.), related organization rules and the like. I do not discuss how to generate automatically treatment consent evaluation rules. Instead, I focus on how to obtain and enforce informed treatment consents for those treatments that require them.

Table 2 Attributes Used in 3 Sample Advance Directives Consent Forms

Attributes	Pain Medicine	Treatment Name	Treatment Description		Alternatives	Effective Period		
Name of Consent								
Medical Orders for Lif-Sustaining Treatment (MOLST) DNR and DNI					X			X
Health Care Treatment Instructions	X	X						X
Advance Care Plan (Tennessee)		X		X				X
Attributes	Patient	Physician License#	DNR	DNI	Quality of life	Hospitalization	Fluids and Nutrition	Antibiotics
Name of Consent								
Medical Orders for Lif-Sustaining Treatment (MOLST) DNR and DNI		X	X	X		X	X	X
Health Care Treatment Instructions	X		X	X			X	
Advance Care Plan (Tennessee)	X				X			
Attributes	Signee	Notary	Date	Healthcare Proxy	Notes			
Name of Consent								
Medical Orders for Lif-Sustaining Treatment (MOLST) DNR and DNI	X		X	X	New York State Department of Health			
Health Care Treatment Instructions	X		X	X	Pennsylvania Department of Health			
Advance Care Plan (Tennessee)	X	X	X	X	Tennessee Department of Health			

Table 3 Attributes Used in Eight Sample Dialysis Forms

Name of Consent	Consent for Dialysis Fistulogram and Possible Angioplasty, Stent Placement or Thrombolytic Therapy	Informed Consent for Hemodialysis	Patient Informaed Consent Form	Consent for Dialysis and Related Treatments	Consent For Treatment	Consent for Dialysis Treatment, ESA Medications & Blood and/or Blood Product Transfusions	Consent for Dialysis Therapy	Consent Form
Attributes								
Patient	X	X	X					X
Physician			X				X	
Information Sharing			X	X	X	X		X
Treatment Name	X	X	X	X	X	X	X	X
Treatment Description	X	X	X		X	X	X	
Lab		X		X				
Benefits	X		X		X	X	X	
Risks	X	X	X	X	X	X	X	
Alternatives	X	X	X	X	X	X	X	
Anemia Treatment					X	X		
ESAs						X		
Transfusions						X		
Dietary Restrictions		X						
Patient Resposibility		X		X				X
Anesthesia		X	X					
Effective Period	X	X						
Signee	X	X	X	X	X	X	X	X
Date	X	X	X	X	X	X	X	
Time	X	X	X	X			X	
Healthcare Proxy					X	X		
Notes	Univeristy of Pennsylvania Health System Department of Radiology Division of Vascular And Interventional Radiology	Hartford Hospital	Verde Valley Medical Center	Barnson Dialysis, L.L.C.	Unity Health System dialysis Services	Unity Health System dialysis Services	Univerity of Virginia Health System	Sils Services Ltd, Dialysis Barbados

Table 4 Sample Attributes Used in Health Care Proxy Forms

Attributes	Patient	DOB	Patient's Address	Patient's Phone	Patient Designee	Relationship to Patient	Desinee's Address	Designee's Phone	Email	Alternative Agent/Proxy
Patient Designee Form	X	X			X	X	X	X		
Health Care Proxy	X		X	X	X	X	X	X		
Durable Health Care Power of Attorney	X		X		X	X	X	X	X	X
Advance Care Plan (Tennessee)	X				X	X	X	X		X
Health Care Proxy Form Instructions	X				X		X	X		X
Health Care Proxy	X				X	X	X	X		X
Massachusetts Health Care Proxy	X		X		X		X	X		X
Health Care Proxy	X		X		X		X	X		X
Health Care Proxy	X				X					X

4.3.1 Main Issues Involving Treatment Consent

Many treatments require obtaining and enforcing patient consent. However, obtaining informed consent is complex. For example, an incapacitated patient (perhaps temporarily due to injury or medication) may be considered to not possess a sound mind, or may have been determined to lack mental capacity (e.g., developmental disorders or clinically determined mental impediments) needed to provide legally binding informed consent. Similar exceptions exist with respect to children or young adults, who may not be considered sufficiently mature to provide consent [55]. This raises the key issue of the age of consent allowing the minor to permit a treatment regime. States apply differing values for the age of consent and may even deem consent as dependent on the kind of treatment. For example, age of consent in Maryland is 17 years, but in Virginia is 18 years. Alabama allows health care consent to be made by minors at 14 years or older [67]. That raises questions such as whether a 15 year-old resident of Virginia who requires medical treatment during a visit to Alabama, can give consent instead of a legal guardian?

The fact that some minors (defined by age under varying State laws as shown above) have rights to provide consents under different conditions (e.g. marital status) adds an additional layer of complexity. I summarize situations under which a minor patient can issue consent to various types of treatment in all 50 States.

Another issue arises during complicated medical workflows where any choices made during treatment may limit a patient's physical and mental capabilities, such as when a patient selects PD vs. HD vs. refusing treatment in the event of kidney failure. Hence, all risks and benefits must be explained and weighed before obtaining consent.

4.3.2 Consent Management System

When our workflow based EMR schedules a treatment, it notifies the CMS. Then, the WfMS decides whether treatment should continue or abort based on the treatment specification and the patient's treatment decision. Figure 25 depicts the CMS, which performs two functions: (i) Obtaining consent from patients; and (ii) retrieving appropriate consent forms based on specific treatment task requirements.

Components that interact with the CMS are:

1. Informed consent trigger: Refers to each specific task in the medical treatment workflow that requires consent.
2. Informed consent repositories: Store all the information related to the treatment consents.
3. Evaluation rule repository: Store rules that codify regulations and healthcare organizational policies related to informed consent and that require the CMS to retrieve applicable consent.

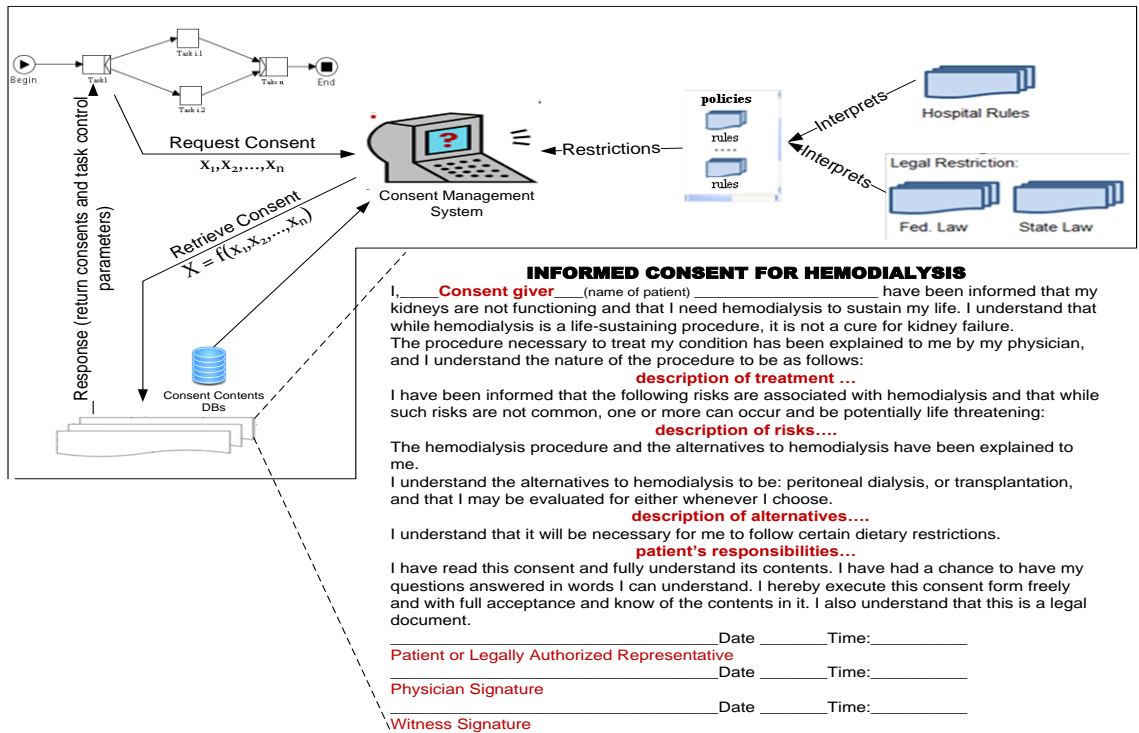

Figure 25 Consent Management System

Figure 26 describes the interaction between the WfMS engine, the EMR and CMS.

1. **(Step 1) EMR → Workflow Engine:** When a caregiver starts a medical treatment procedure in the EMR, a “launch case” event request with workflow specification I.D. or name is sent to the workflow engine. The workflow engine enables some work item(s). If the enabled work item(s) does not request Consent Service, then the *workflow engine* enables other appropriate work items based on control flow defined in the workflow specification, and notifies the EMR. Then, the interactions between the workflow engine and the EMR are repeated. Otherwise, **(stated in Step 6)**

the EMR checks the enabled work item(s) and executes them.

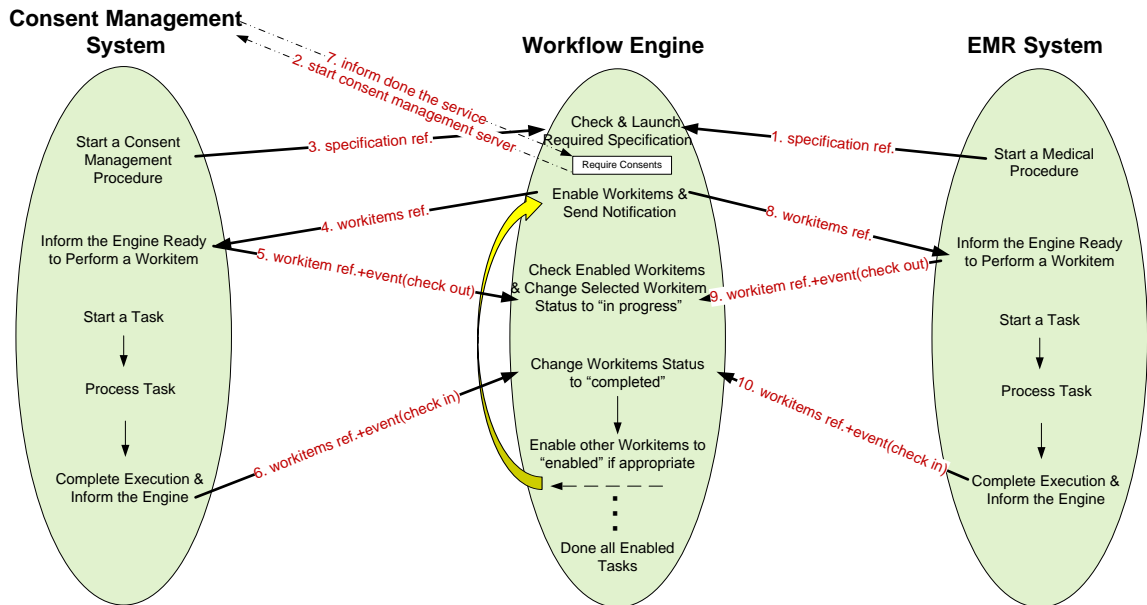

Figure 26 Workflow Engine – EMR Interaction (per session, implement by using YAWL engine [6])

2. **(Step2)** Workflow Engine → CMS: If a task needs to check patient's informed consent, the consent management service is triggered.
3. **(Step 3)** CMS → Ontology Service (OS): CMS uses OWL, an API, to connect to the OS with patient's information and other required consent information. An individual has been created and can use Pellet to reason appropriate outcomes.
4. **(Step 4)** OS → CMS: OS returns the results reasoned based on Semantic Web Rule Language (SWRL) rules to CMS.
5. **(Step 5)** CMS → Workflow Engine: CMS passed results to the workflow

engine, if valid consents have been held, obtaining consent from patient's medical records; otherwise, asks the EMR (**Step 6**) to retrieve appropriate consent forms based on specific treatment task requirements.

6. (**Step 7**) EMR → CMS: EMR request the CMS to provide the kind of required consent.
7. (**Step 8**) CMS →EMR: CMS returns the answers to the EMR. The decision whether the treatment should continue or aborted based on the treatment specification and also based on the patient's treatment decision.

At design time, based on rules and regulations, the CMS designer decides to add the applicable consent service. If no consents apply, then the EMR will not require any patient consents as shown in Figure 27. When a treatment requires having a patient's consent before progressing further, the CMS designer uses the GUI shown in Figure 28 to add a consent service.

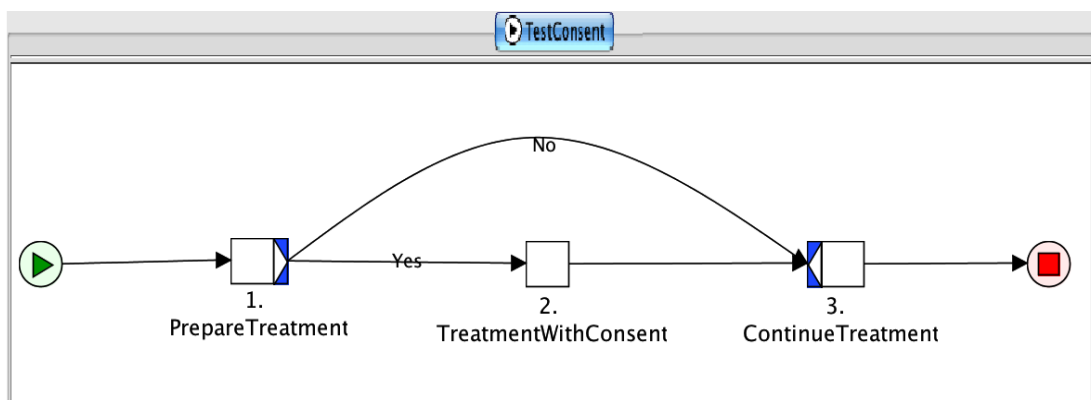

Figure 27 Example of a Treatment Specification

Add Service

Name:

Password: **Confirm Password:**

URI:

Description:

Figure 28 Adding Consent Management System as Custom Service into YAWL

Test Consent Specification (See, Figure 27):

1. **Step 1-** Prepare Treatment (CareGiver): The caregiver prepares a treatment. The outcome of this process is whether the treatment consent is required or not and whether the patient has the capability to give consent or not. C (Condition): Outcome of the consent requirement.
2. **Step 2-** Treatment with Consent (System): If the treatment requires consent, this task is automatically delegated to CMS. A Consent Workflow specification starts. (Figure 29 provides more detail)
3. **Step 3-** Continue Treatment (CareGiver): The caregiver continues treatment if either the treatment does not require consent (outcome from Step 1) or the required consent is obtained and the patient accepts treatment.

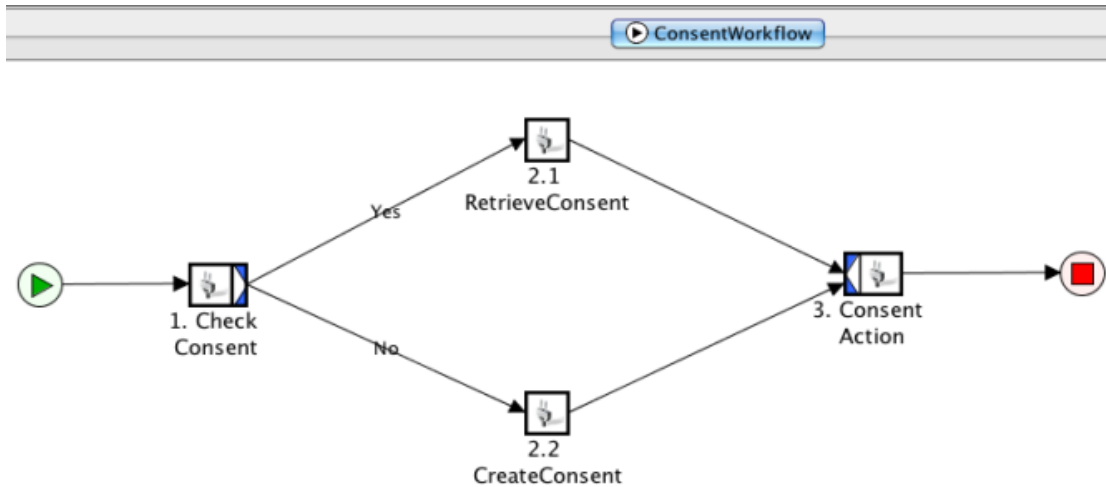

Figure 29 Consent Management Workflow

Consent Management Workflow Specification (See, Figure 29):

1. **Step 1** - Check Consent (CMS): the CMS checks for existing consent. If the consent is available, the CMS checks to see whether it's usable, because the existing consent may not apply due to expiration etc.

C (Condition): Outcome of the consent information: Yes; no; or yes, but unusable.

2. **Step 2.1** - Retrieve Existing Consent (System): The system obtains the information of existing consent if the system found the required consent has been given and is usable from **Step 1**.
3. **Step 2.2** - Create Treatment Consent (System): The system retrieves appropriate treatment consent form if system found the required consent is missing or unusable from **Step 1**.

4. **Step 3 - Consent Action (System):** The system either returns the result (accepting or rejecting) of the given treatment consent (from **Step 2.1**) or returns with the appropriate consent form (from **Step 2.2**).

The consent evaluation rules were created using OWL DL in Protégé ontology environment and used an inference engine, Pellet reasoner, to infer implicit knowledge of consent in order to obtain appropriate consent forms. Chapter 5 describes the Ontology and Chapter 6 describes the rules.

During run time, when a specific treatment is scheduled, the EMR system will automatically call the CMS. The EMR system passes all attributes required to determine the kind of required consent, such as the consent type, patient medical record's identification, patient's State of performing treatment (to determine applicable rules), age, marital status, financial status etc. This data is used to check whether consent already exists. If not, it will be obtained before providing treatment. All obtained consents are stored as a part of the patient record in the EMR system.

4.3.3 Implementation

For consistency, I still used YAWL management system as WfMS and OpenMRS as EMR system. In section 4.3.2, I used a simplified HD treatment with consent requirement as a case study to demonstrate the implementation of the workflow in OpenMRS. The care provider selects a patient (See, Figure 30) after successfully logging into the EMR system.

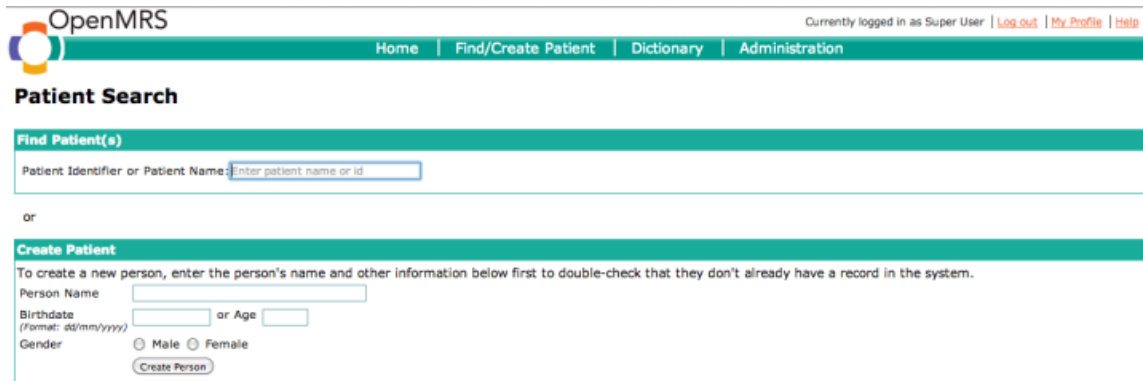

Figure 30 Find a Patient from OpenMRS System

1. After enrolling a patient and launching the workflow, our system automatically loads the first “*PrepareTreatment*” task into OpenMRS. Figure 31 shows a user interface that allows caregiver(s) to check if the treatment requires explicit consent.

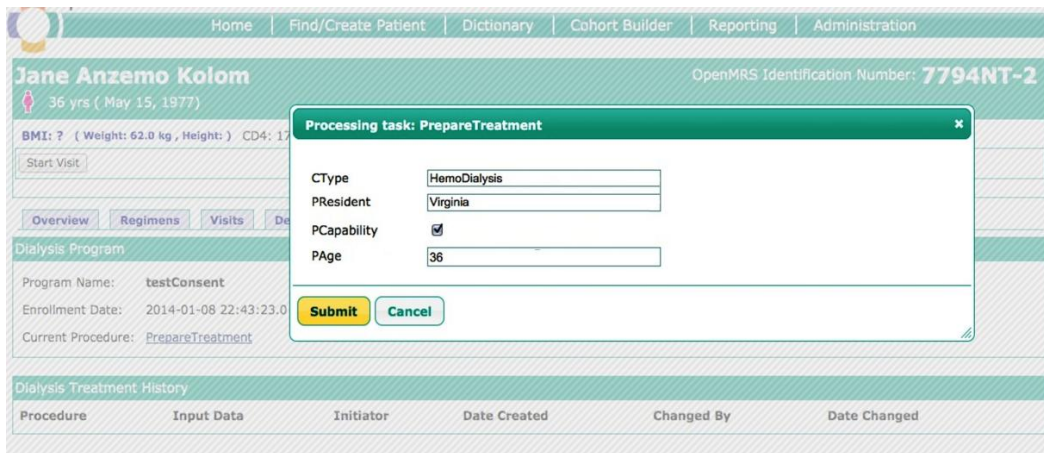

Figure 31 Check Treatment Consent Requirements

2. After completing Task 1, the WfMS enables a task based on the value gained from Task 1, continue treatment or process the treatment consent requirement. If this treatment does not require consent, “ContinueTreatment” task is enabled. Otherwise, “TreatmentWithConsent” task starts and is delegated to the consent management system. The consent workflow (See, Figure 29), is imported.

2.1 The CMS starts the first task “CheckConsent” to check whether required consent has been given and the consent status. If consent has been given, “RetrieveConsent” task will be enabled, followed by “ConsentAction” task to return the consent status of given consent. Figure 32 shows required consent has been given, and the patient accepted treatment. In that case, the test consent workflow moves to “ContinueTreatment” task.

Procedure	Input Data	Initiator	Date Created	Changed By	Date Changed
PrepareTreatment	<PrepareTreatment><CType>HemoDialysis</CType><PResident>Virginia</PResident><PCapability>true</PCapability><PAge>36</PAge></PrepareTreatment>	Yu,Bo	2014-01-09 16:20:33.0	Yu,Bo	2014-01-09 16:20:42.0
Check Consent	<Check_Consent> hasConsent>true</hasConsent> </Check_Consent>	Yu,Bo	2014-01-09 16:20:42.0	Yu,Bo	2014-01-09 16:20:48.0

Figure 32 Consent has been Given by the Patient

2.2 “CheckConsent” is completed. If consent has not been given, “CreateConsent” task is enabled. In this paper, this task does not

automatically generate a consent form because I assume all consent forms are pre-defined and stored in OpenMRS. This task, based on transferred necessary information and evaluation rule, retrieves an appropriate consent form via user interface on OpenMRS to display to users. After submitting the filled-in consent form, WfMS will enforce the test consent workflow. Figure 33 shows a patient capable of filling out consent and accepting treatment; in that case, the test consent workflow moves to “*ContinueTreatment*” task. Figure 34 shows a patient with capability filling out consent and choosing to reject treatment; in that case, the test consent workflow is aborted. The entire workflow finished.

Processing task: CreateConsent

INFORMED CONSENT FOR HEMODIALYSIS

I, Consent giver (name of patient) Jane Anzemo Kolom have been informed that my kidneys are not functioning and that I need hemodialysis to sustain my life. I understand that while hemodialysis is a life-sustaining procedure, it is not a cure for kidney failure.

The procedure necessary to treat my condition has been explained to me by my physician, and I understand the nature of the procedure to be as follows:

description of treatment

I have been informed that the following risks are associated with hemodialysis and that while such risks are not common, one or more can occur and be potentially life threatening:

description of risks

The hemodialysis procedure and the alternatives to hemodialysis have been explained to me. I understand the alternatives to hemodialysis to be: peritoneal dialysis, or transplantation, and that I may be evaluated for either whenever I choose.

description of alternatives

I understand that it will be necessary for me to follow certain dietary restrictions.

patient's responsibilities

I have read this consent and fully understand its contents. I have had a chance to have my questions answered in words I can understand. I hereby execute this consent form freely and with full acceptance and know of the contents in it. I also understand that this is a legal document.

By checking, I consent the treatment.

Patient or Legally Authorized Representative
Jane Anzemo Kolom Date: 01/08/2014

Physician Signature _____ Date: _____

Dialysis Program

Program Name: **testConsent**

Enrollment Date: 2014-01-09 16:17:41.0 Started by Yu,Bo

Current Procedure: ContinualTreatment ←

Dialysis Treatment History

Procedure	Input Data	Initiator	Date Created	Changed By	Date Changed
PrepareTreatment	<PrepareTreatment> <CType>HemoDialysis</CType> <PResident>Virginia</PResident> <PCapability>true</PCapability> <PPage>36</PPage> </PrepareTreatment>	Yu,Bo	2014-01-09 16:17:41.0	Yu,Bo	2014-01-09 16:17:51.0
Check Consent	<Check_Consent> <hasConsent>false</hasConsent> </Check_Consent>	Yu,Bo	2014-01-09 16:17:51.0	Yu,Bo	2014-01-09 16:18:02.0
CreateConsent	<CreateConsent> </physician> </physician> <CStatus>Consent</CStatus> <pSignature>Jane Anzemo Kolom</pSignature> <pDate>01/09/2014</pDate> </physicianDate> </physicianDate> </CreateConsent>	Yu,Bo	2014-01-09 16:18:02.0	Yu,Bo	2014-01-09 16:18:15.0

Figure 33 Patient Submits an “Accept Treatment” Consent

INFORMED CONSENT FOR HEMODIALYSIS

I, Consent giver (name of patient) Jane Anzemo Kolom have been informed that my kidneys are not functioning and that I need hemodialysis to sustain my life. I understand that while hemodialysis is a life-sustaining procedure, it is not a cure for kidney failure.

The procedure necessary to treat my condition has been explained to me by my physician, and I understand the nature of the procedure to be as follows:

description of treatment

I have been informed that the following risks are associated with hemodialysis and that while such risks are not common, one or more can occur and be potentially life threatening:

description of risks

The hemodialysis procedure and the alternatives to hemodialysis have been explained to me. I understand the alternatives to hemodialysis to be: peritoneal dialysis, or transplantation, and that I may be evaluated for either whenever I choose.

description of alternatives

I understand that it will be necessary for me to follow certain dietary restrictions.

patient's responsibilities

I have read this consent and fully understand its contents. I have had a chance to have my questions answered in words I can understand. I hereby execute this consent form freely and with full acceptance and know of the contents in it. I also understand that this is a legal document.

By checking, I consent to the treatment. ← **Reject Treatment**

Patient or Legally Authorized Representative
Jane Anzemo Kolom Date: _____

Physician Signature
 _____ Date: _____

Submit Cancel

Dialysis Program

Program Name: **testConsent**

Enrollment Date: 2014-01-09 16:16:28.0 Started by Yu,Bo

Completion Date: 2014-01-09 16:16:55.0 Finished by Yu,Bo ← **Do not move to ContinueTreatment Task**

Start Dialysis Treatment

Dialysis Treatment History

Procedure	Input Data	Initiator	Date Created	Changed By	Date Changed
PrepareTreatment	<PrepareTreatment> <CType>HemoDialysis</CType> <PResident>Virginia</PResident> <PCapability>true</PCapability> <Page>36</Page> </PrepareTreatment>	Yu,Bo	2014-01-09 16:16:28.0	Yu,Bo	2014-01-09 16:16:39.0
Check Consent	<Check_Consent> <hasConsent>>false</hasConsent> </Check_Consent>	Yu,Bo	2014-01-09 16:16:39.0	Yu,Bo	2014-01-09 16:16:45.0
CreateConsent	<CreateConsent> <CStatus>no</CStatus> <physicianDate> </physicianDate> <pSignature>Jane Anzemo Kolom</pSignature> <physician> </physician> <pDate> </pDate> </CreateConsent>	Yu,Bo	2014-01-09 16:16:45.0	Yu,Bo	2014-01-09 16:16:55.0

Figure 34 Patient Submit a “Reject Treatment” Consent

4.3.4 Evaluation and Conclusion

Obtaining consents at runtime and enforcing consents for medical treatments will reduce medical malpractice, potential medical treatment errors caused by missing informed consents, and improve the patient-caregiver relationship.

CHAPTER FIVE ONTOLOGY FOR MEDICAL TREATMENT CONSENT

5.1 Introduction

As stated above, over the years, many federal, state, and local governments and healthcare organizations have developed laws, regulations, and guidelines for obtaining and memorializing informed consent. Herein, I model these decision-making constrained conditions as consent rules and the decision-making system as the consent rule management system.

Issuing proper medical treatment consent demands evaluating all consent rules and determining the kind of consent to be obtained from the legally acceptable consent provider. However, as also stated above, consent laws and regulations are complex. At times ambiguity adds to complexity. This has caused breakdowns between the concepts that people use and the data that computers interpret. Moreover, these laws and regulations have changed and are still changing over time—i.e., the laws are dynamic. Yet, there has been no implementation method or modeling of the changes to health treatment consent laws in order to use them in this manner. Also, literature concerning treatment-related consent laws is scarce and, in any event, soon rendered unreliable if not obsolete by changes to such laws. Thus, methodology for acquiring proper consent based on current rules must be similarly dynamic.

However, without a sound semantic understanding of informed treatment consent, it is impossible to make consent information semantics explicit and hence discoverable automatically in a software system; a mechanism to implement e-consent is needed to address this, but to the best of my knowledge none now exist. Thus, in this dissertation I create a medical treatment consent ontology as a preliminary notation to formalize the predicates used in creating my rules. I provide a methodology to develop the evaluation rule repository by using the predicates I developed, resulting in a medical treatment consent ontology.

5.2 Ontologies

Computer science defines “Ontology” as “the explicit specification of a conceptualization” [68] or “explicit formal specifications of the terms in the domain and relations among them” [69]. Consequently, ontologies can be used to model a domain of discourse as a set of representative primitives, such as classes, object properties, data properties and relationships between them.

Many papers present reasons to use ontologies to formulate shared vocabulary (knowledge) of a given healthcare domain of interest [70] to ensure interoperability within the various healthcare domains (by ontology matching) [71]. I developed an ontology to be used in consent servers that serves the following purposes:

- 1) Sharing the common understanding of the structure of information among people or software agent [70, 72]. I reuse my treatment consent domain knowledge to extend domain knowledge or to combine it with other

domain ontologies such as Systematized Nomenclature of Medicine (SNOMED).

- 2) Easily changing domain assumptions if the knowledge about the domain changes. This requirement exists because treatment consent evaluation rules change frequently, for example due to malpractice lawsuits triggering new consent laws or new regulations to be annexed.
- 3) Separating domain knowledge from operational knowledge. Existing EMR systems do not need knowledge about consent rule management systems and an ontology to use a consent server.

5.3 Ontologies in the Healthcare Domain

Ontologies have been used to represent actionable knowledge in biomedicine [73 - 77] due to their ability to capture domain knowledge in a formal yet simple and incremental manner, as well as their easy and powerful application in reasoning processes [78]. Other healthcare fields include decision support and information integration. The proposed applications are: BioPAX, an ontology for the exchange and interoperability of biological pathway (cellular processes) data [79]; Cell Cycle Ontology (CCO), Application Ontologies (APO) that integrate diverse types of knowledge with the CCO and the Gene Expression Knowledge Base (GexKB) [80]; Disease Ontology, designed to facilitate mapping of diseases and associated conditions to particular medical codes [81]; Linkbase, a formal representation of the biomedical domain, founded upon Basic Formal Ontology [82]; NCBO Bioportal, biological and biomedical ontologies and associated tools to search, browse and visualize [83]; NIFSTD Ontologies from the Neuroscience

Information Framework: a modular set of ontologies for the neuroscience domain [84]; Systematized Nomenclature of Medicine — Clinical Terms [85]; OBO Foundry, a suite of interoperable reference ontologies in biology and biomedicine [86]; OBO-Edit, an ontology browser for most of the Open Biological and Biomedical Ontologies [87]; PRO, the Protein Ontology of the Protein Information Resource, Georgetown University [88]; and so on. Yet, leveraging the technique for informed treatment consent in EMR system remains lacking. Herein my methodology addresses this gap.

5.4 Related Work

As mentioned previously, consent rule management system is an important component for consent servers to obtain and evaluate required treatment consents automatically. Many strategies are used to design and implement consent decision management, one being hard-coding decision rules in EMRs [89]. This method's drawback is making such embedded consent rules difficult to find, understand and change.

My workflow-based EMR system's consent management cures those shortcomings. By adding informed consent as a service to careflow management in an EMR system, the careflow itself can change. My design strategy separates CMS from existing EMR systems so the EMR systems are unaffected by any changes in consent decision rules. In addition, the CMS can also be used by many different EMR systems simultaneously.

5.5 Ontology-based Reasoning to Derive Informed Treatment Consents

Three components support ontology-based reasoning to derive informed treatment

consents:

- 1) Ontology-editing environments create concepts (predicates and relationships among them) and properties of informed treatment consents and relationships among them;
- 2) A set of consent evaluation rules codify treatment consent laws and regulations; and
- 3) A reasoner supports rule-based ontology inferences. Figure 35 shows a high-level view of ontology-based reasoning used in my CMS.

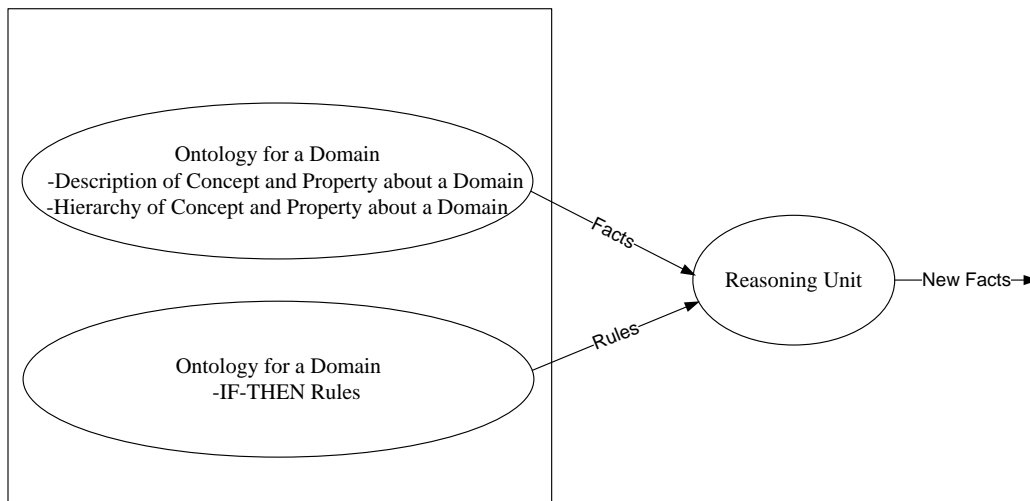

Figure 35 High-level view of ontology-based knowledge reason

5.5.1 Entities of Medical Treatment Consent Ontology

After studying several medical treatments in actual medical facilities, I combined information obtained from interviews with paper-based documents used to record events and data that are associated with the workflows. That analysis revealed common entities related to the informed treatment consents domain:

1. Patient: The person seeking medical treatment. A patient may or may not be an *Informed consent giver* depending on treatments and his/her conditions (e.g., age, maturity, mental capacity).
2. Treatment: A method of combating, ameliorating, or preventing a disease, disorder, or injury. Usually, the treatment contains several procedures, also called tasks in the treatment workflow specifications.
3. Treatment performance location: Where the treatment is carried out, some treatments may be not allowed to be performed in some States. It is not matter where the patient's residence.
4. Informed treatment consent: During treatment procedures, informed treatment consents may confirm that patients permitted such procedures that are involved in a patient seeking treatment. Some procedures may not require any written informed consent; some must have one, or more than one informed consent(s) before performing the treatment procedure; some may require informed consents that do not affect performing procedures at this point.

5.5.2 Classes, Properties of the Treatment Consent Ontology

1. Patient: A person seeking medical treatment. Each patient also associates with a set of attributes that depends on the patient's demographic information such as age, name, etc., and patient active status that is used to evaluate maturity.
2. Treatment: The methods the patient seeks to combat, ameliorate, or prevent a disease, disorder, or injury. Each treatment has a treatment name, such as eye surgery, dialysis, etc.
3. Procedures: Generally, every treatment consists of a set of pre-defined procedures. Each procedure has a name.
4. Consent: Medical consents are legal documents. The outputs of consents are patient decisions, such as obtaining treatment or sharing health data with specified agencies or people.
5. TreatmentConsent: A class of Consent that expresses the patient's desire to receive a treatment regime and his/her permission for a caregiver or facility to provide the care. As stated, the specific consent may depend on the treatment procedures, and on state or federal laws or sub-discipline regulations. Each consent for the treatment procedures has a name. For example, anesthesia consent.
 - (1) MandatoryConsent: A sub-class of TreatmentConsent. It must permit receiving the treatment before doing it. Even the same consent may be mandatory in some cases, such as anesthesia

consent for a surgery.

(2) **OptionalConsent**: A sub-class of **TreatmentConsent** whose omission does not prevent the treatment. An example is anesthesia consent for giving birth, where the patient does not have to provide explicit consent.

6. **AdultPatient**: A patient with maturity status. A competent adult patient is allowed to provide his/her own treatment consent.

7. **MinorPatient**: Is a patient not yet considered to be an adult. Without an exception such as an emergency, minor patients by themselves cannot provide legally acceptable treatment consent.

8. **PerformInState**: State where treatment will be provided.

5.5.3 Properties (express the relationship of two classes) in Ontology

Table 5 Properties Table

Property Name	Domain	Range
<i>asksMandatoryConsentByPatient</i>	Patient class	MandatoryConsent
<i>asksOptionalConsentByPatient</i>	Patient class	OptionalConsent class
<i>has</i>	Treatment class	Procedures class
<i>isPatient</i>	AdultPatient class or MinorPatient class	Patient class
<i>isState</i>	PerformInState class	State class
<i>needsMandatoryConsent</i>	Procedures class	MandatoryConsent class
<i>needsOptionalConsent</i>	Procedures class	OptionalConsent class
<i>performedIn</i>	Treatment class	State class
<i>requiresMandatoryConsent</i>	Procedures class	Consent class
<i>requiresOptionalConsent</i>	Procedures class	Consent class

Table 5 shows the relationship between two classes. Properties may have a domain and a range specified. For example, Row1 in the above table indicates:

asksMandatoryConsentByPatient: Links individuals belonging to the class Patient to individuals belonging to the class MandatoryConsent.

Figure 36 shows entities of treatment consent ontology developed in Protégé 4.3.

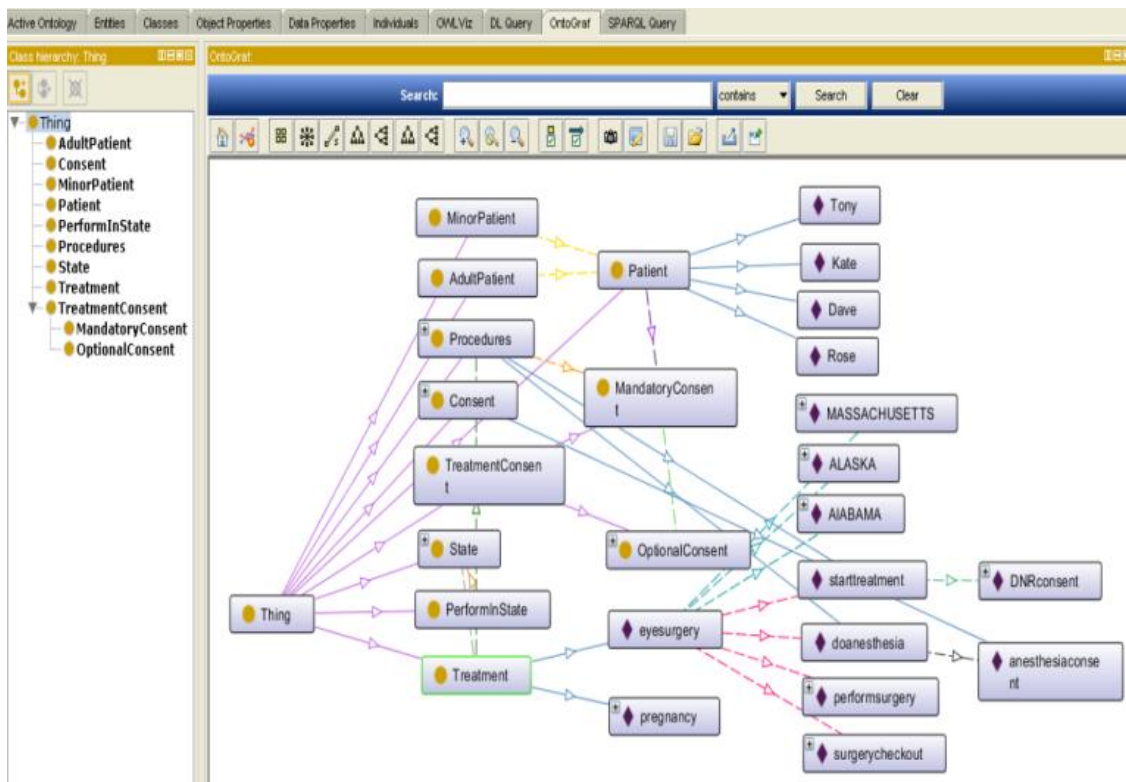

Figure 36 Entities of treatment consent ontology

CHAPTER SIX RULE-BASED IMPLEMENTATION IN WORKFLOW-BASED EMR SYSTEM

6.1 Introduction

This chapter shows how to: create a CMS using the consent ontology described in Chapter 5; codify consent rules using the predicates and relationships on my consent ontology; and use those rules in auto-generating consent forms for medical treatments.

6.2 Informed Treatment Consent Rules

Consent is valid if it adheres to the laws that govern specific institutional practices [90]. The rules applied in consent have the following components:

Rule 1: *Information or Disclosure*: Disclosure of relevant information to the patient or patient's representative(s) about the treatment by physician(s) [91]. Two main standards used here are: (i) The patient standard of disclose; and (ii) the professional standard to disclose. Twenty-five states follow the "patient standard," whereas twenty-three adhere to the "professional standard." The laws in two states, Colorado and Georgia, cannot be neatly classified within those two categories [92]. Nonetheless, the scope of disclosure of required information is still debated.

Rule 2: *Decisional Capability*: Evaluation of patient competency for understanding treatment and procedure information and the ability to provide a rational, voluntary decision about the treatment. In [93], authors described four psycho-legal standards of (i) communicating a choice, (ii) factual understanding, (iii) appreciation of

the situation, and (iv) rational manipulation of information, that are used to evaluate patient competence in granting consent. However, to date no widespread consensus exists on how the decisional capacity of treatment consent should be measured.

Rule 3: Competency: Validation of patient maturity to grant informed consent. For informed treatment consents, an essential component is the concept of autonomy that allows competent adult persons and emancipated children to make their own healthcare decisions.

Examination of many paper-based consent forms reveals that the various rules applied the following consent components:

1. Informed consent giver (governed by Rule 3 - competency): The person with the legal right to make health care decisions, such as parents or legal guardians of minors, healthcare proxies, healthcare providers or third-parties.
2. Treatment information (governed by Rule 1 -information or disclosure): At a minimum, includes treatment name, procedures for this treatment, treatment location.
3. Patient's decision of the treatment (governed by Rule 2 - decisional capability): Includes the decision (deny or accept) by providing all required conditions such as patient's and other attributes such as signatures, date, etc.

Treatment consents must be based on all input variables, such as consent giver, treatment specification, related consent rules, etc. Usually, they are represented in the

physical forms of written, electronic forms in the computer applications, or in some other legally acceptable way.

Consent laws are at times interdependent. For example, the definition of patient's maturity in healthcare is not only dependent on a patient's age, but also depends on the type of treatment and location where the treatment is to be provided. The age of consent for various medical treatments differs among States. Most States set the age at 18 years, but Alabama allows healthcare consent to be made by minors 19 years of age and older [67]. The following laws provide other relevant examples:

- Age for consent may differ depending on treatment. In California, for General Medical Treatments, Cal. Fam. Code § 6500 provides 18 years of age or older is allowed to give their own treatment consent. However, for Pregnancy (not including sterilization and abortion), CAL. FAM. CODE § 6925 (2012) states that, “A minor may consent to medical care related to the prevention or treatment of pregnancy.”
- Even if patients are minors, if they have certain active status, they are allowed to provide consents for some treatments. For example, (1) Cal. Fam. Code § 7050 provides that an emancipated minor may consent for medical, dental, or psychiatric care without parental consent, knowledge, or liability; (2) Cal. Fam. Code § 6922 allows consent from a minor when that a minor, 15 years of age or older, lives separate and apart from the minor's parents or guardian, whether with or without the consent of a parent or guardian and regardless of the duration of the separate residence, when the

minor is managing the minor's own financial affairs, regardless of the source of the minor's income;

Some consent rules do not provide specific provisions explicitly, but are derived by combining laws. For example, Cal. Fam. Code § 7002 provides “a minor who has married is emancipated.” According to another rule (Cal. Fam. Code § 7050), an emancipated minor may consent for medical, dental, or psychiatric care without parental consent, knowledge, or liability.

My CMS has rules to determine patient maturity for each State based on its consent laws. Table 6 shows a partial summary of 50 States’ patient maturity evaluation rules:

Table 6 Patient Maturity Evaluating Rules (50 STATES)

State	State Abbreviation	General Medical Treatment	Pregnancy
ALABAMA	AL	19 years of age or older (Ala. Code § 26 1 1)	1. Any minor (Ala. Code § 22-8-6);
		1. Minor age equal or greater than 18, less than 19, and minor has an emancipation order (Ala. Code §§ 26-13-1 and 26-13-5); 2. Minor age 14 or old, has graduated from high school (Ala. Code § 22-8-4); 3. Minor is married (Ala. Code § 22-8-4; Ala. Code § 22-8-5); 4. Minor having been married and divorced (Ala. Code § 22-8-4; Ala. Code § 22-8-5); 5. Minor is pregnant (Ala. Code § 22-8-4); 6. Minor has child(ren) (Ala. Code § 22-8-5);	
• • • • •			
CALIFORNIA	CA	18 years of age or older (Cal. Fam. Code § 6500)	1. An unemancipated minor (Cal. Fam. Code § 6925);
		1. Minor is an emancipation minor (Cal. Fam. Code § 7050); 2. Minor is 15 years of age or older, who is living separate and apart from the minor's parents or guardian and managing the minor's own financial affairs (Cal. Fam. Code § 6922); 3. Married Minor is an emancipation minor (Cal. Fam. Code § 7002); 4. Minor is 16 years of age or older, who serves in the armed forces of the United States or has court order is an emancipated minor (CAL. FAM. CODE § 6950 (2012));	
• • • • •			
WYOMING	WY	18 years of age or older (Wyo. Stat. Ann. § 14 1 101(a))	1. No explicit law
		1. Minor is or was legally married – minor is married, widow (Wyo. Stat. Ann. § 14-1-101(b)); 2. Minor is or was legally married – minor is divorced (Wyo. Stat. Ann. § 14-1-101(b)); 3. Minor who is in active military service of the United States may consent for healthcare treatment (Wyo. Stat. Ann. § 14-1-101(b)); 4. Minor who is living apart from his parents or guardian and managing his/her own affairs may consent for healthcare treatment(Wyo. Stat. Ann. § 14-1-101(b)); 5. Minor is an emancipated minor (Wyo. Stat. Ann. § 14-1-101(b));	

6.3 Deriving Informed Treatment Consents

The rules used to model treatment consents are of the form

“ $\text{predicate}_1(x_{11}, x_{12}, \dots, x_{1n}), \dots, \text{predicate}_i(x_{i1}, x_{i2}, \dots, x_{ij}), \dots, \text{predicate}_m(x_{m1}, x_{m2}, \dots, x_{mk}) \rightarrow$
 $\text{predicate}(y_1, \dots, y_p)$ ”

where the body of predicate instances before the arrow symbol \rightarrow are taken as the body of the rule and read as a conjunction of

$\text{predicate}_1(x_{11}, x_{12}, \dots, x_{1n}) \wedge, \dots, \wedge \text{predicate}_i(x_{i1}, x_{i2}, \dots, x_{ij}) \wedge, \dots, \wedge \text{predicate}_m(x_{m1}, x_{m2}, \dots, x_{mk})$ and

the consequent is $\text{predicate}(y_1, \dots, y_p)$. The intended meaning can be read as: Whenever the conditions specified in the antecedent hold, then the conditions specified in the consequent also hold. Now I show how I specified the patient maturity rules of California as an example to explain SWRL rules:

- For General Treatment (we consider eye surgery belonging to general treatment)
 1. Minor is an emancipation minor who may consent for medical, dental, or psychiatric care, without parental consent, knowledge, or liability. (Cal. Fam. Code § 7050);
 2. Minor is 15 years of age or older, who is living separate and apart from the minor's parents or guardian and managing the minor's own financial affairs (Cal. Fam. Code § 6922) is an emancipated minor;
 3. Married Minor is an emancipated minor (Cal. Fam. Code § 7002);
 4. Minor is 16 years of age or older, who serves in the United States Armed Forces or has a court order (Cal. Fam. Code § 6950);
- For Pregnancy Treatment (exclude to be Sterilized and to receive Abortion)

1. An un-emancipated minor may consent for medical care related to the prevention or treatment of pregnancy (Cal. Fam. Code § 6925);

Let S be a SWRL knowledge base, where $\{t, p, s\}$ is a set of OWL class names. In here, $\{t, p, s\}$ refers to $\{\text{Treatment, Patient, and State}\}$ coordinately. *performedIn* is an OWL property name to show the relationship between Treatment and State, and $\{\text{"eyesurgery"}, \text{"CA"}, \text{age}, \text{fi}, \text{ls}, \text{m}, \text{iem}, \text{iaf}, \text{hco}, \text{tpi}\}$ is a set of OWL constants and SWRL variables. Age refers to patient's age; *fi* refers to patient's financial status; *ls* refers to patient's resident status; *m* refers to patient's marital status; *iem* refers to patient maturity level; *iaf* refers to patient's career status; *hco* refers to a legal issue related to patient, *tpi* refers to patient seeking treatment, which is an attribute of Patient. Some SWRL rules have the form:

Example 1:

- (1) $\left\{ \begin{array}{l} \text{patientRequiresTreatment}(?p, \text{"eyesurgery"}), \\ \text{hasAge}(?p, ?\text{age}), \\ \text{patientFinancialIndependent}(?p, ?\text{fi}), \\ \text{patientLivesSeparately}(?p, ?\text{ls}), \end{array} \right.$
- (2) $\left\{ \begin{array}{l} \text{hasTreatmentName}(?t, \text{"eyesurgery"}), \\ \text{patientTreatmentPerformedIn}(?p, ?\text{tpi}), \\ \text{hasStateName}(?s, ?\text{tpi}), \text{performedIn}(?t, ?s), \\ \text{containsIgnoreCase}(\text{"AL || AK || CA || MA"}, ?\text{tpi}), \end{array} \right.$
- (3) $\left\{ \begin{array}{l} \text{containsIgnoreCase}(\text{"T"}, ?\text{fi}), \\ \text{containsIgnoreCase}(\text{"T"}, ?\text{ls}), \end{array} \right.$
- (4) $\text{lessThan}(?age, 16), \text{greaterThanOrEqual}(?age, 15)$
- (5) $\rightarrow \text{AdultPatient}(?p)$

Example 1 is based on CA Consent Laws for General Medical Treatment: See, Rule 2 of CA shown in Table 6.

Example 2:

- (1) { patientRequiresTreatment(?p, "eyesurgery"),
hasAge(?p, ?age),
patientFinancialIndependent(?p, ?fi),
patientLivesSeparately(?p, ?ls),
patientMarried(?p, ?m),
patientIsEmancipatedMinor(?p, ?iem),
patientIsArmedForce(?p, ?iaf),
patientHasCourtOrder(?p, ?hco),
patientIsEmancipatedMinor(?p, ?iem),
- (2) { hasTreatmentName(?t, "eyesurgery"),
patientTreatmentPerformedIn(?p, ?tpi),
hasStateName(?s, ?tpi), performedIn(?t, ?s),
containsIgnoreCase("AL || AK || CA || MA", ?tpi),
- (3) { stringConcat(?v, ?fi, ?ls),
containsIgnoreCase("FF-FT-TF", ?v),
containsIgnoreCase(?iem, "F"),
containsIgnoreCase("F", ?m),
containsIgnoreCase("T-F", ?iaf),
containsIgnoreCase("T-F", ?hco),
- (4) lessThan(?age, 16), greaterThanOrEqual(?age, 15)
- (5) → MinorPatient(?p)

Example 2 is based on CA consent Laws for General Medical Treatment: rule1 ~ rule4 of CA shown in Table 6.

Part (1) defined a set of constants (called OWL constants) and variables (called SWRL variables) of a specific patient. Some of the constants can be retrieved from EMRs.

Part (2) checks whether the treatment sought may be performed in the State; which treatment may be performed in which States is known information; part (3) sets up rules; part (4) provides constrains; part (5) implies the consequent ((5)) from the antecedent ((1) ~ (4)).

I create a general maturity rule syntax table (see, Table 8) and, according to the related State consent laws, use rules to infer the expected results. Evaluation is shown in section 6.4.

6.4 Evaluation

This section shows how I translated the rules stated in English to SWRL rules.

First, I show general rule syntax and their explanation. (See, Table 7)

Table 7 General Maturity Rule Syntax

State	predicates	Meaning	Related State Law
ALABAMA - AL	$\text{patientRequiresTreatment}(p, tn) \wedge (tn = \text{"generalTreatment"}) \wedge \text{hasTreatmentName}(t, tn) \wedge \text{patientTreatmentPerformedIn}(p, sn) \wedge (sn = \text{"AL"}) \wedge \text{hasStateName}(s, sn) \wedge \text{performedIn}(t, s) \wedge \text{hasAge}(p, age) \wedge (age \geq 19) \rightarrow$	If 19 years of age or older, patient p has treatment t with treatment name tn is "generalTreatment" performed in state s with state name sn is "AL", and treatment t is allowed performing in state s , this patient p is adult patient. Where t is treatment with name tn of patient required; s is state with sn	19 years of age or older (Ala. Code § 26-1-1)

	AdultPatient(p)	where patient performs treatment t ; age is age of patient p	
	<p>patientRequiresTreatment(p, tn) \wedge (tn = "generalTreatment") \wedge hasTreatmentName(t, tn) \wedge patientTreatmentPerformedIn(p, sn) \wedge (sn = "AL") \wedge hasStateName(s, sn) \wedge performedIn(t, s) \wedge patientHasEmancipationOrder(p, heo) \wedge (heo = True) \wedge hasAge(p, age) \wedge (19 > age \geq 18) \rightarrow AdultPatient(p)</p>	<p>If 18 years of age or older and less than 19 years old, patient p has treatment t with treatment name tn is "generalTreatment" performed in state s with state name sn is "AL", treatment t is allowed performing in state s, and patient has an emancipation order, this patient p is adult patient. Where t is treatment with name tn of patient required; s is state with state name sn where patient performs treatment t; heo is status of holding an emancipation order of patient p; age is age of patient p</p>	<p>1. Minor age equal or greater than 18, less than 19, and minor has an emancipation order (Ala. Code §§ 26-13-1 and 26-13-5);</p>
	<p>patientRequiresTreatment(p, tn) \wedge (tn = "generalTreatment") \wedge hasTreatmentName(t, tn) \wedge patientTreatmentPerformedIn(p, sn) \wedge (sn = "AL") \wedge hasStateName(s, sn) \wedge performedIn(t, s) \wedge patientGraduatedFromHighschool(p, gfhs) \wedge (gfhs = True) \wedge hasAge(p, age) \wedge (age \geq 14) \rightarrow AdultPatient(p)</p>	<p>If 14 years of age or older, patient p has treatment t with treatment name tn is "generalTreatment" performed in state s with state name sn is "AL", treatment t is allowed performing in state s, and patient graduated from high school, this patient p is adult patient. Where t is treatment with name tn of patient required; s is state with state name sn where patient performs treatment t; $gfhs$ is status</p>	<p>2. Minor age 14 or older, has graduated from high school (Ala. Code § 22-8-4);</p>

		of graduation from high school of patient p ; age is age of patient p	
<p> $patientRequiresTreatment(p, tn) \wedge (tn = \text{"generalTreatment"}) \wedge hasTreatmentName(t, tn) \wedge patientTreatmentPerformedIn(p, sn) \wedge (sn = \text{"AL"}) \wedge hasStateName(s, sn) \wedge performedIn(t, s) \wedge patientMarried(p, m) \wedge (m = True) \wedge hasAge(p, age) \wedge (age < 19) \rightarrow AdultPatient(p)$ </p>	<p> If less than 19 years old, patient p has treatment t with treatment name tn is "generalTreatment" performed in state s with state name sn is "AL", treatment t is allowed performing in state s, and patient married, this patient p is adult patient. Where t is treatment with name tn of patient required; s is state with state name sn where patient performs treatment t; m is marital status of patient p; age is age of patient p </p>	<p>3. Minor is married (Ala. Code § 22-8-4; Ala. Code § 22-8-5);</p>	
<p> $patientRequiresTreatment(p, tn) \wedge (tn = \text{"generalTreatment"}) \wedge hasTreatmentName(t, tn) \wedge patientTreatmentPerformedIn(p, sn) \wedge (sn = \text{"AL"}) \wedge hasStateName(s, sn) \wedge performedIn(t, s) \wedge patientDivorced(p, d) \wedge (d = True) \wedge hasAge(p, age) \wedge (age < 19) \rightarrow AdultPatient(p)$ </p>	<p> If less than 19 years old, patient p has treatment t with treatment name tn is "generalTreatment" performed in state s with state name sn is "AL", treatment t is allowed performing in state s, and patient divorced, this patient p is adult patient. Where t is treatment with name tn of patient required; s is state with state name sn where patient performs treatment t; d is marital status of patient p; age is age of patient p </p>	<p>4. Minor have married but divorced (Ala. Code § 22-8-4; Ala. Code § 22-8-5);</p>	

Then I use an example to show use of the inference engine. The example is the scenario where a 15 year-old patient named Kate seeks eye surgery (treatment) in California with the following characteristics.

1. Unmarried;
2. Not been evaluated to be an emancipated minor;
3. Lacks a court order giving her the right to issue her own medical consent ;
4. Does not serve in the United States Armed Forces;
5. Does not live with parents; and
6. Manages her own financial affairs.

Under these conditions, based on my translation of the rules, my consent service infers that Kate is an adult patient according to California law. Therefore, she may provide treatment consent, despite her age being under California law's maturity age.

Table 8 Part of Consent Rules Syntax of Patient Maturity for General and Pregnancy Treatment in 50 States

State	State Abbreviation	SWRL rule	
		General Medical Treatment	Pregnancy
ALABAMA	AL	hasTreatmentName(?t, "eyesurgery"), patientRequiresTreatment(?p, "eyesurgery"), hasAge(?p, ?age), patientTreatmentPerformedIn(?p, ?tpi), hasStateName(?s, ?tpi), performedIn(?t, ?s), containsIgnoreCase("AL", ?tpi), greaterThanOrEqual(?age, 19) -> AdultPatient(?p)	hasTreatmentName(?t, "pregnancy"), patientRequiresTreatment(?p, "pregnancy"), patientTreatmentPerformedIn(?p, ?tpi), hasStateName(?s, ?tpi), performedIn(?t, ?s), containsIgnoreCase("AL", ?tpi) -> AdultPatient(?p)
		hasTreatmentName(?t, "eyesurgery"), patientRequiresTreatment(?p, "eyesurgery"), hasAge(?p, ?age), patientDivorced(?p, ?d), patientIsPregnant(?p, ?ip), patientMarried(?p, ?m), patientHasChild(?p, ?hc), stringConcat(?v, ?m, ?d, ?ip, ?hc), containsIgnoreCase(?v, "T"), patientTreatmentPerformedIn(?p, ?tpi), hasStateName(?s, ?tpi), performedIn(?t, ?s), containsIgnoreCase("AL", ?tpi), lessThan(?age, 19) -> AdultPatient(?p)	
•••••			
CALIFORNIA	CA	hasTreatmentName(?t, "eyesurgery"), patientRequiresTreatment(?p, "eyesurgery"), hasAge(?p, ?age), patientTreatmentPerformedIn(?p, ?tpi), hasStateName(?s, ?tpi), performedIn(?t, ?s), containsIgnoreCase("CA", ?tpi), greaterThanOrEqual(?age, 18) -> AdultPatient(?p)	hasTreatmentName(?t, "pregnancy"), patientRequiresTreatment(?p, "pregnancy"), patientTreatmentPerformedIn(?p, ?tpi), hasStateName(?s, ?tpi), performedIn(?t, ?s), containsIgnoreCase("CA", ?tpi) -> AdultPatient(?p)
		hasTreatmentName(?t, "eyesurgery"), patientRequiresTreatment(?p, "eyesurgery"), hasAge(?p, ?age), patientFinancialIndependent(?p, ?fi), patientLivesSeparately(?p, ?ls), patientMarried(?p, ?m), patientIsEmancipatedMinor(?p, ?iem), patientIsArmedForce(?p, ?iaf), patientHasCourtOrder(?p, ?hco), containsIgnoreCase("F", ?hco), patientIsEmancipatedMinor(?p, ?iem), stringConcat(?u, ?fi, ?ls), containsIgnoreCase("FF-FT-TF", ?u), stringConcat(?v, ?iaf, ?hco), containsIgnoreCase("FF-FT-TF-TT", ?v), containsIgnoreCase(?iem, "F"), containsIgnoreCase(?m, "F"), patientTreatmentPerformedIn(?p, ?tpi), hasStateName(?s, ?tpi), performedIn(?t, ?s), containsIgnoreCase("CA", ?tpi), lessThan(?age, 16), greaterThanOrEqual(?age, 15) -> MinorPatient(?p)	
•••••			
WYOMING	WY	hasTreatmentName(?t, "eyesurgery"), patientRequiresTreatment(?p, "eyesurgery"), hasAge(?p, ?age), patientMarried(?p, ?m), patientDivorced(?p, ?d), patientIsArmedForce(?p, ?iaf), patientIsEmancipatedMinor(?p, ?iem), stringConcat(?v, ?m, ?d, ?iaf, ?iem), containsIgnoreCase(?v, "T"), patientTreatmentPerformedIn(?p, ?tpi), hasStateName(?s, ?tpi), performedIn(?t, ?s), containsIgnoreCase("WY", ?tpi), lessThan(?age, 18) -> AdultPatient(?p)	1. No explicit law

In my hypothetical scenario, Pellet uses facts that are data properties of an individual of the class Patient, instantiated to Kate, and object properties of Kate. (See, Example 1.)

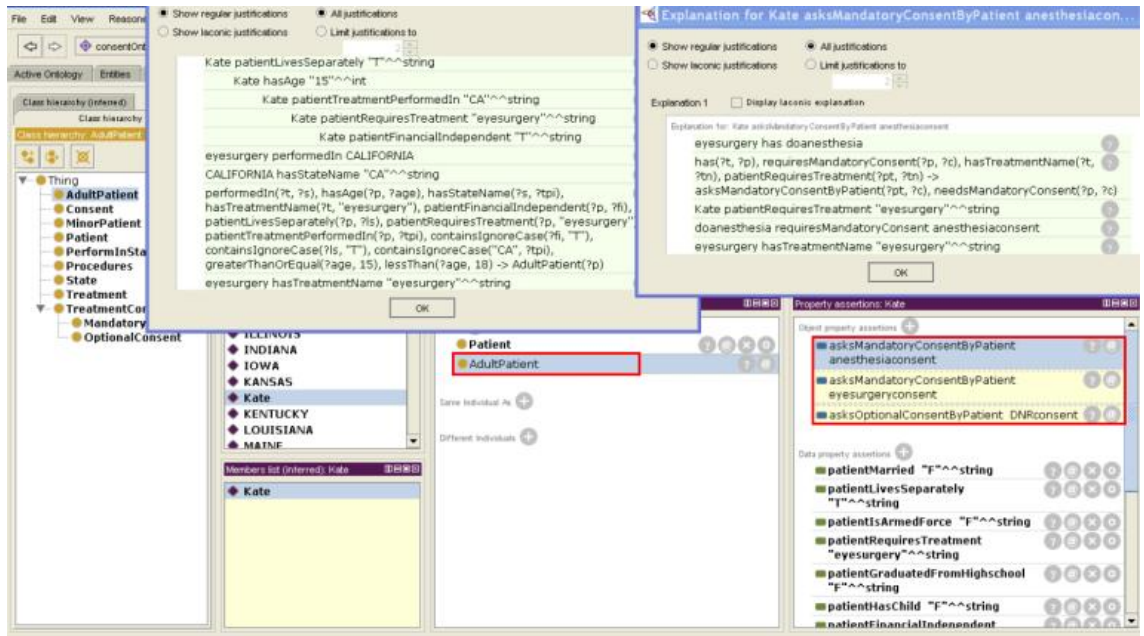

Figure 37 Outcome of the proof of patient maturity using Pellet reasoner

As Figure 37 shows, Kate is considered an adult by Pellet with the explanation shown on the right-hand side. In this example, the left red box shows that result. The explanation is as follows.

Explanation for: Kate Type AdultPatient

1. Kate has Age “15”
2. Kate patientRequiresTreatment “eyesurgery”
3. Kate patientTreatmentPerformedIn “CA”
4. Kate patientFinancialIndependent “T”
5. Kate patientLivesSeparately “T”
6. eyesurgery hasTreatmentName “eyesurgery”
7. CALIFORNIA hasStateName “CA”

8. eyesurger performedIn CALIFORNIA
9. performedIn(?t, ?s), hasAge(?p, ?age), hasStateName(?s, ?tpi),
hasTreatmentName(?t, "eyesurgery"), patientFinancialIndependent(?p, ?fi),
patientLivesSeparately(?p, ?ls), patientRequiresTreatment(?p,
"eyesurgery"), patientTreatmentPerformedIn(?p, ?tpi),
containsIgnoreCase(?fi, "T"), containsIgnoreCase(?ls, "T"),
containsIgnoreCase("CA", ?tpi), greaterThanOrEqual(?age, 15),
lessThan(?age, 18)

Under these conditions, according to my translation of the rules, my consent service infers that Kate is an adult patient according to California law. Therefore, she may provide treatment consent by herself, despite her age being under California law's maturity age.

The inputted facts of individual Patient, Kate, are shown in line 1 ~ line 6 from Kate's data properties. Line 9 is the rule used by Pellet to infer out the new fact that Kate is an adult patient based on her activity status using this particular rule. Automatically using ontologies ensures that those consents comply with consent laws.

CHAPTER SEVEN CONCLUSIONS AND FUTURE WORK

7.1 Conclusions

Workflow-enforced EMR systems allow treatment workflows embedded in existing EMR systems. On one hand, workflow-based EMR systems enforce well-defined treatment workflow to ensure a care team follows the treatment plan from one step to another, thereby avoiding the disadvantages and harm from deviation from law, procedures or policies. It conforms to healthcare industry development trends by improving patient safety and healthcare treatment outcomes; and by tracking safety and its relationship to utilized workflows. Moreover, the workflow-enforced EMR system enables continuous improvement through its audit and data retention functions.

On the other hand, the nature of medical treatment requires that EMR systems also have sufficient flexibility to handle unexpected situations—e.g., allow treatment to continue when, in the provider’s judgment, the best care necessitates moving to the next task even if a prerequisite task is incomplete as specified. I anticipate and facilitate such exceptions by allowing care providers to bypass unfinished tasks and move the workflow forward. However, these exceptions must be recorded in the workflow management system so that they can be reviewed for quality of care and perhaps used to improve the workflow itself.

When I add an executable consent-enforced service into such workflow-based EMR systems to manage informed consent in existing EMR systems at runtime, that includes not only all the benefits provided by workflow enforced EMR systems [94], but also significantly benefits medical practitioners in reducing medical malpractice and potential medical treatment errors caused by missing informed consents [95]; improving the patient-caregiver relationship; risk management; decreasing costs associated with malpractice; and audit/continuous improvement. Additionally, this system can accommodate changes to policies and standards.

My approach stores all consents in the EMR system. The processes of gaining the consents and including exception processes are also recorded in the workflow management system, thus available for quality of care audits and reviews.

Finally, using ontology techniques in a consent management system and creating a consent ontology enable keeping current each State's consent laws.

My dissertation introduces an inspiring framework to extend existing EMR systems to avoid treatment errors caused by deviation from standardized treatment workflow.

7.2 Future Work

Future work will expand this EMR system to generate automatically required consent rules caused by revised or new laws to make the system quickly reflect these changes; to allow patients to revoke consents; and to appoint or re-appoint consent holders. This research path also includes further developing the evaluation rule repository to cover other more specific scenarios.

REFERENCES

- [1] Authority, P. P. S. (2010). *Hemodialysis administration: Strategies to ensure safe patient care*. Pennsylvania Patient Safety Advisory, 7(3): 87-96.
- [2] Quaglini, S., Stefanelli, M., Cavallini, A., Micieli, G., Fassino, C., & Mossa, C. (2000). *Guideline-based careflow systems*. Artificial intelligence in medicine, 20(1): 5-22
- [3] Wang, D., Peleg, M., Tu, S. W., Shortliffe, E. H., & Greenes, R. A. (2001). *Representation of clinical practice guidelines for computer-based implementations*. Studies in health technology and informatics, (1): 285-289
- [4] Haynes, A.B., Weiser, T.G., et al. (2009). *A surgical safety checklist to reduce morbidity and mortality in a global population*. N Engl J Med. 360: 491-9
- [5] Semel, M.E., Resch, S., et al. (2010). *Adopting a surgical safety checklist could save money and improve the quality of care in U.S. hospitals*. Health Affairs, 29(9): 1593-9
- [6] Lingard, L., Regehr, G., et al. (2008). *Evaluation of a preoperative checklist and team briefing among surgeons, nurses and anesthesiologist to reduce failures in communication*. Archives of Surgery, 143(1): 12-17
- [7] Bulletin of the American College of Surgeons. (2002). *Statement on ensuring correct patient, correct site, and correct procedure surgery*. Bull Am Coll. Surg. 87(12): 26
- [8] American College of Surgeons. (2006). *Wrong site surgery and the Universal Protocol*. Bull Am Coll. Surg. 91(11): 63
- [9] World Alliance for Patient Safety. (2008). *WHO guidelines for safe surgery*. Geneva: World Health Organization
- [10] Joint Commission. (2007). *Frequently asked questions about the universal protocol for preventing wrong site, wrong procedure, wrong person surgery*. Available at The Joint Commission website:

http://www.jointcommission.org/standards_information/up.aspx Accessed June, 2010

- [11] Lingard, L., Regehr, G., et al. (2008). *Evaluation of a preoperative checklist and team briefing among surgeons, nurses and anesthesiologist to reduce failures in communication*. Archives of Surgery, 143(1): 12-17
- [12] Wang, D., Peleg, M., Tu, S. W., Boxwala, A. A., Greenes, R. A., Patel, V. L., & Shortliffe, E. H. (2002). *Representation primitives, process models and patient data in computer-interpretable clinical practice guidelines: A literature review of guideline representation models*. International Journal of Medical Informatics, 68(1): 59-70
- [13] Wang, D., Peleg, M., Tu, S. W., Boxwala, A. A., Ogunyemi, O., Zeng, Q., Greenes, R. A., Patel, V. L., and Shortliffe, E. H. (2004). *Design and implementation of the GLIF3 guideline execution engine*. Journal of biomedical informatics 37, no. 5: 305-318
- [14] Maviglia, S. M., Zielstorff, R. D., Paterno, M., Teich, J. M., Bates, D. W., and Kuperman, G. J. (2003). *Automating complex guidelines for chronic disease: lessons learned*. Journal of the American Medical Informatics Association 10.2: 154-165.
- [15] Kim, S. W., Maturo, S., Dwyer, D., Monash, B., Yager, P. H., Zanger, K., & Hartnick, C. J. (2012). *Interdisciplinary development and implementation of communication checklist for postoperative management of pediatric airway patients*. Otolaryngology--Head and Neck Surgery 146, no. 1: 129-134
- [16] Gardner, E. (1992). *Putting guidelines into practice*. Modern healthcare 22, no. 36: 24
- [17] Albuquerque, K. V., Miller, A. A., & Roeske, J. C. (2011). *Implementation of Electronic Checklists in an Oncology Medical Record: Initial Clinical Experience*. Journal of Oncology Practice 7, no. 4: 222-226
- [18] Agarwal, S., Joshi, A., Finin, T., Yesha, Y., & Ganous, T. (2007). *A Pervasive Computing System for the Operating Room of the Future*. Mobile Networks and Applications 12(2/3). 215–228
- [19] Bardram, J.E., Nørskov, N. (2008). *A context-aware patient safety system for the operating room*. In Proceedings of the 10th international conference on Ubiquitous computing, 272–281

- [20] Quaglini, S., Stefanelli, M., Cavallini, A., Micieli, G., Fassino, C., & Mossa, C. (2000). *Guideline-based careflow systems*. *Artificial intelligence in medicine* 20, no. 1: 5-22
- [21] Ardissono, L., Di Leva, A., Petrone, G., Segnan, M., & Sonnessa, M. (2006). *Adaptive medical workflow management for a context-dependent home healthcare assistance service*. *Electronic Notes in Theoretical Computer Science (ENTCS)*. 146(1):59–68
- [22] Dazzi, L., Stefanelli, M. (1997). *A patient workflow management system built on guidelines*. In *Proc. of American Medical Informatics Association (AMIA)* 97: 146–150
- [23] Poulymenopoulou, M., & Vassilacopoulos, G. (2001). *A web-based workflow system for emergency healthcare*. *Studies in health technology and informatics*, 90: 707-711
- [24] American Medical Association. (2008). *Professional Resources (Legal Issues) Informed Consent*. Available at: <http://www.ama-assn.org/ama/pub/category/4608.html> Accessed on March 15, 2009
- [25] Dialog Medical. *Healthcare's most expensive piece of paper*. Available at: <http://www.dialogmedical.com/wp-content/uploads/2010/04/ROI%20White%20Paper%2005-07.pdf> Accessed May, 2013
- [26] Compbell D. (June, 2004). *Case and Commentary – Listen to the family*. *Morbidity & Mortality Rounds on the Web*. AHRQ. Available at: <http://webmm.ahrq.gov/case.aspx?caseID=62> Accessed August, 2013
- [27] Haynes, A. B., Weiser, T. G., Berry, W. R., Lipsitz, S. R., Breizat, A. H. S., Dellinger, E. P., et al. (2009). *A surgical safety checklist to reduce morbidity and mortality in a global population*. *New England Journal of Medicine* 360.5: 491-499
- [28] de Vries, E. N., Prins, H. A., Crolla, R. M., den Outer, A. J., van Andel, G., van Helden, S. H., et al. (2010). *Effect of a comprehensive surgical safety system on patient outcomes*. *New England Journal of Medicine* 363.20: 1928-1937
- [29] Wachter, R. M. (2010). *Patient safety at ten: unmistakable progress, troubling gaps*. *Health Affairs* 29.1: 165-173

- [30] Weiser, T. G., Haynes, A. B., Dziekan, G., Berry, W. R., Lipsitz, S. R., & Gawande, A. A. (2010). *Effect of a 19-item surgical safety checklist during urgent operations in a global patient population*. *Annals of surgery* 251.5: 976-980
- [31] Vats, A., Vincent, C. A., Nagpal, K., Davies, R. W., Darzi, A., & Moorthy, K. (2010). *Practical challenges of introducing WHO surgical checklist: UK pilot experience*. *BMJ*: 340
- [32] Haynes, A. B., Weiser, T. G., Berry, W. R., Lipsitz, S. R., Breizat, A. H. S., Dellinger, E. P., et al. (2011). *Changes in safety attitude and relationship to decreased postoperative morbidity and mortality following implementation of a checklist-based surgical safety intervention*. *BMJ quality & safety* 20.1: 102-107
- [33] Gawande, A. (2012). *How do we heal medicine?* TED April. Available at: http://www.ted.com/talks/atul_gawande_how_do_we_heal_medicine.html?utm_medium=social&source=email&utm_source=email&utm_campaign=ios-share Accessed on March 15, 2014
- [34] Chertow, G. M., Lee, J., Kuperman, G. J., Burdick, E., Horsky, J., Seger, D. L., et al. (2001). *Guided medication dosing for inpatients with renal insufficiency*. *Journal of the American Medical Association*, 286(22): 2839-2844.
- [35] Jani, Y. H., Ghaleb, M. A., Marks, S. D., Cope, J., Barber, N., & Wong, I. C. K. (2008). *Electronic prescribing reduced prescribing errors in a pediatric renal outpatient clinic*. *The Journal of pediatrics*, 152(2): 214-218.
- [36] Kochevar, J., Gitlin, M., Mutell, R., Sarnowski, J., & Mayne, T. (2010). *Electronic medical records: a survey of use and satisfaction in small dialysis organizations*. *Nephrology nursing journal: journal of the American Nephrology Nurses' Association*, 38(3): 273-281.
- [37] Sargent, J.A. (2002). *Identifying the value of computers in dialysis*. *Blood Purification*, 20(1): 11-19
- [38] Guarnieri, S. (2013). *What's the big deal? Chairside charting with a clinical information system*. *Renal Business Today*, Available at: www.hiiweb.com/Documents/RBT_11_06Pgs18-22.pdf Accessed May, 2013

- [39] Uphoff, M. E., & Krane, D. (1998). *Hospital-based technology assessment: Essential questions and an operational model*. Public Productivity & Management Review: 60-70.
- [40] Martin, D., Shulman, K., Santiago-Sorrell, P., & Singer, P. (2003). *Priority-setting and hospital strategic planning: a qualitative case study*. Journal of Health Services Research & Policy, 8(4), 197-201.
- [41] Greenhalgh, T.; Robert, G.; Bate, P.; Macfarlane, F. & Kyriakidou, O. (2005). *Diffusion of Innovations in Health Service Organizations: A Systematic Literature Review*, Blackwell, Oxford (UK)
- [42] OpenMRS Website. *OpenMRS Developer Guide*. Available at: <https://wiki.openmrs.org/display/docs/Developer+Guide> Accessed May, 2013
- [43] YAWL Website. *YAWL Technical Manual 2.1 version*. Available at: <http://www.yawlfoundation.org/manuals/YAWLTechnicalManual2.1.pdf> Accessed May, 2013.
- [44] Wager, K. A., Lee, F. W., & Glaser, J. P. (2005). *Managing Health Care Information Systems: A Practical Approach for Health Care Executives*. John Wiley & Sons.
- [45] Shortliffe, E. H., & Cimino, J. J. (2006). *Biomedical informatics*. Springer Science + Business Media, LLC.
- [46] Locatelli, P., Restifo, N., Gastaldi, L., & Corso, M. (2012). *Health care information systems: architectural models and governance*. Innovative Information Systems Modeling and Techniques.
- [47] Wickramasinghe, N. & Geisler, E. (Eds.) (2008). *Encyclopedia of Healthcare Information Systems*. Medical Information Science Reference, Hershey (PA)
- [48] Lenz, R., & Reichert, M. (2007). *IT support for healthcare processes—premises, challenges, perspectives*. Data & Knowledge Engineering, 61(1): 39-58.
- [49] Daugirdas, J. T., Blake, P. G., & Ing, T. S. (Eds.) (2007). *Handbook of dialysis (Vol. 236)*. Wolters Kluwer Health.

- [50] USRDS 2009 Annual Data Report. (2009). *Treatment Modalities*. USRDS 2009 Annual Data Report, Ch4. Available at: www.usrds.org/2007/pdf/04_modalities_07.pdf Accessed April, 2013.
- [51] YAWL Website. *YAWL User Manual*. Available at: <http://www.yawlfoundation.org/yawldocs/YAWLUserManual2.0.pdf> Accessed May, 2013.
- [52] Mamlin, B. W., Biondich, P. G., Wolfe, B. A., Fraser, H., Jazayeri, D., Allen, C., ... & Tierney, W. M. (2006). *Cooking up an open source EMR for developing countries: OpenMRS—a recipe for successful collaboration*. In AMIA Annual Symposium Proceedings (Vol. 2006, p. 529). American Medical Informatics Association.
- [53] Kurtz, G. (2002). *EMR confidentiality and information security*. Journal of healthcare information management: JHIM, 17(3), 41-48.
- [54] *Salgo v. Leland Stanford, Jr., Univ. Bd. of Trustees*, 317 P. 2d 170-181 (Cal. App. Ct. 1957).
- [55] Appelbaum, P.S., and Thomas G. (1995). *The MacArthur Treatment Competence Study. I: Mental illness and competence to consent to treatment*. Law and human behavior 19.2, 105.
- [56] Coiera, E., Clark, R. (Mar/April 2004). *e-Consent: The design and Implementation of consumer consent mechanisms in an electronic environment*. Journal of the American Informatics Association (JAMIA) Vol. 11, No 2.
- [57] Ruan, C., & Yeo, S. S. (2009). *Modeling of an Intelligent e-Consent System in a Healthcare Domain*. J. UCS, 15(12), 2429-2444.
- [58] Russello, G., Dong, C., & Dulay, N. (2008). *Consent-based workflows for healthcare management*. In *Policies for Distributed Systems and Networks, POLICY*. IEEE Workshop on (pp. 153-161).
- [59] O’Keefe, C. M., Greenfield, P., & Goodchild, A. (2005). *A decentralized approach to electronic consent and health information access control*. Journal of Research and Practice in Information Technology, vol. 37, no. 2, pp. 161–178.

- [60] Bergmann, J., Bott, O. J., Pretschner, D. P., & Haux, R. (2007). *An econsent-based shared EHR system architecture for integrated healthcare networks*. *International Journal of Medical Informatics*, vol. 76, pp.130–136.
- [61] Win, K. T., Fulcher, J. A. (2007). *Consent mechanisms for electronic health record systems: A simple yet unresolved issue*. *Journal of Medical Systems*, vol. 31, pp. 91–96.
- [62] Sheppard, N. P., Safavi-Naini, R., & Jafari, M. (2009). *A digital rights management model for healthcare*. In *Policies for Distributed Systems and Networks*. POLICY 2009. IEEE International Symposium on (pp. 106-109).
- [63] Win, K., Song, H., Croll, P., and Cooper, J., (2002). *Implementing patients consent in electronic health record systems*. Proceedings of COLLECTeR, Melbourne, Australia.
- [64] Grimson, J., Stephens, G., Jung, B., Grimson, W., Berry, D., Pardon, S., (2001). *Sharing health-care records over the internet*. *IEEE Internet Comput.* 5(3) 49–58.
- [65] Saranummi, N. (2005). *PICNIC architecture*. *Studies in health technology and informatics*, 115, 37-60.
- [66] VHA HANDBOOK 1004.05, Transmittal Sheet, (March, 2005). *IMEDCONSENT™*. Available at: http://www.va.gov/vhapublications/ViewPublication.asp?pub_ID=1857 Accessed August, 2013
- [67] Bourgeois, F. C., Taylor, P. L., Emans, S. J., Nigrin, D. J., & Mandl, K. D. (2008). *Whose personal control? Creating private, personally controlled health records for pediatric and adolescent patients*. *Journal of the American Medical Informatics Association*, 15(6), 737-743.
- [68] Gruber, T. R. (1995). *Toward principles for the design of ontologies used for knowledge sharing?*. *International journal of human-computer studies*, 43(5), 907-928.
- [69] Noy, N. F., McGuinness, D. L. (2001). *Ontology development 101: A guide to creating your first ontology*.
- [70] Gruber, T. R. (1993). *A translation approach to portable ontology specifications*.

Knowledge acquisition, 5(2), 199-220.

- [71] Garde, S., Knaup, P., Hovenga, E. J., & Heard, S. (2007). *Towards Semantic Interoperability for Electronic Health Records--Domain Knowledge Governance for open EHR Archetypes*. *Methods of information in medicine*, 46(3), 332-343.
- [72] Musen, M. A. (1992). *Dimensions of knowledge sharing and reuse*. *Computers and biomedical research*, 25(5), 435-467.
- [73] Rosse, C., & Mejino Jr, J. L. (2003). *A reference ontology for biomedical informatics: the Foundational Model of Anatomy*. *Journal of biomedical informatics*, 36(6), 478-500.
- [74] Yu, A. C. (2006). *Methods in biomedical ontology*. *Journal of biomedical informatics*, 39(3), 252-266.
- [75] Dang, J., Hedayati, A., Hampel, K., Toklu, C. (2008). *An ontological knowledge framework for adaptive medical workflow*. *J Biomed Inform*, 41:829–36.
- [76] Matos, E. E., Campos, F., Braga, R., Palazzi, D., (2010). *CelOWS: an ontology based framework for the provision of semantic web services related to biological models*. *Journal of biomedical informatics*, 43(1), 125-136.
- [77] Valls, A., Gibert, K., Sánchez, D., & Batet, M. (2010). *Using ontologies for structuring organizational knowledge in Home Care assistance*. *International Journal of Medical Informatics*, 79(5), 370-387.
- [78] Riaño, D., Real, F., López-Vallverdú, J. A., Campana, F., Ercolani, S., Mecocci, P., and Caltagirone, C., (2012). *An ontology-based personalization of health-care knowledge to support clinical decisions for chronically ill patients*. *Journal of biomedical informatics*, 45(3), 429-446.
- [79] Bader, G. D., & Cary, M. P. (2005). *BioPAX—Biological Pathways Exchange Language*. Level 2, Version 1.0 Documentation, doi: <http://www.biopax.org/release/biopax-level2-documentation.pdf>.
- [80] Semantic Systems Biology Website. *About CCO and GexKB*. Available at: <http://www.semantic-systems-biology.org/apo/> Access on December 3, 2013
- [81] Osborne, J. D., Flatow, J., Holko, M., Lin, S. M., Kibbe, W. A., Zhu, L. J., and Chisholm, R. L., (2009). *Annotating the human genome with Disease Ontology*. *BMC genomics*, 10(Suppl 1), S6.

- [82] Van Gorp, M., Decoene, M., Holvoet, M., and dos Santos, M. C., (November, 2006). *LinKBase, a Philosophically-Inspired Ontology for NLP/NLU Applications*. In KR-MED.
- [83] Whetzel, P. L., and et al. (2013). *NCBO Technology: Powering semantically aware applications*. J. Biomedical Semantics, 4(S-1), S8.
- [84] Bug, W. J., Ascoli, J., Grethe, S., Gupta, A., Fennema-Notestine, C., Laird, A. R., ... and Martone, M. E., (2008). *The NIFSTD and BIRNLex vocabularies: building comprehensive ontologies for neuroscience*. Neuroinformatics, 6(3), 175-194.
- [85] Stearns, M. Q., Price, C., Spackman, K. A., and Wang, A. Y., (2001). *SNOMED clinical terms: overview of the development process and project status*. In Proceedings of the AMIA Symposium (p. 662). American Medical Informatics Association.
- [86] Smith, B., Ashburner, M., Rosse, C., Bard, J., Bug, W., Ceusters, W., ... and Lewis, S., (2007). *The OBO Foundry: coordinated evolution of ontologies to support biomedical data integration*. Nature biotechnology, 25(11), 1251-1255.
- [87] Day-Richter, J., Harris, M. A., Haendel, M., and Lewis, S., (2007). *OBO-Edit—an ontology editor for biologists*. Bioinformatics, 23(16), 2198-2200.
- [88] Natale, D. A., Arighi, C. N., Barker, W. C, Blake, J. A., Bult, C. J., Caudy, M., ... and Wu, C. H., (2011). *The Protein Ontology: a structured representation of protein forms and complexes*. Nucleic acids research, 39(suppl 1), D539-D545.
- [89] Wang, X. S., Nayda, L., & Dettinger, R. (2007). *Infrastructure for a clinical-decision-intelligence system*. IBM Systems Journal, 46(1), 151-169.
- [90] Beauchamp, T. L., Childress, J. F., (1989). *Principles of Biomedical Ethics*. Third Edition. New York: Oxford University Press, 1–470.
- [91] Grisso, T., & Appelbaum, P. S., (1998). *Assessing competence to consent to treatment: A guide for physicians and other health professionals*. Oxford University Press.
- [92] Studdert, D. M., Mello, M. M., Levy, M. K., Gruen, R. L., Dunn, E. J., Orav, E. J., and Brennan, T. A., (2007). *Geographic variation in informed consent law: two standards for disclosure of treatment risks*. Journal of Empirical Legal Studies, 4(1), 103-124,

- [93] Fisher, C. B., (2002). *Goodness-of-Fit Ethic for Informed Consent*. A. Fordham Urb. LJ, 30, 159.

- [94] Yu, B., & Wijesekera, D., (2013). *Building Dialysis Workflows into EMRs*. HCIST - International Conference on Health and Social Care Information Systems and Technologies, Procedia Technology, 9, 985-995.

- [95] Yu, B., Wijesekera, D., & Paulo, C., (2014). *Consent-Based Workflow Control in EMRs*. HCIST - International Conference on Health and Social Care Information Systems and Technologies, 72-79.

BIOGRAPHY

Bo Yu received her Bachelor of Science from Beijing University of Aeronautics and Astronautics in 1999. She was employed in two IT companies in Beijing, China for over five years and received her Master of Science in Information Security and Assurance from George Mason University in 2007.